

电路图册说明

- 本手册中的线束零部件明细编号、接插件命名、配电盒接口命名、电路维修图中保险，继电器等参照比亚迪标准制定。
- 本手册中的电路维修图配置舒适型、豪华型、尊贵型。
- 本手册中的电路图中的线色说明如下：

线色标准

代码	B	L	Br	G	Gr	Lg	O	P	R	V	W	Y
颜色	黑	蓝	棕	绿	灰	浅绿	橙黄	粉红	红	紫	白	黄

●电路图编码举例

1、电路图中线束接插件编码举例：

- 1.1、电路图中编码 G2X，G 表示仪表板线束，2 表示仪表板主配电盒，X 表示仪表板主配电盒 X 口的接插件；
- 1.2、电路图中编码 KJG02，K 表示地板线束，J 表示线束间对接接插件，G 表示仪表板线束，02 表示有地板接仪表板线束排序代码为 02。
- 1.2、电路图中编码 B68，B 表示前舱线束，第二位为空表示一般类接插件，68 表示前舱线束排序代码为 68。

2、电路图中保险编码举例：

- 2.2.1、电路图中编码 F1/15 的保险，F 表示保险，1 表示前舱主配电盒，/表示分隔代码，15 表示排序代码为 15 号保险。
- 2.2.1、电路图中编码 FG/8，F 表示保险，G 表示仪表板线束里外挂独立保险，/表示分隔代码，8 表示排序代码为 8 号保险。

3、电路图中继电器编码举例：

- 3.3.1、电路图中编码为 K1/5 的继电器，K 表示外置继电器，1 表示前舱主配电盒，/表示分隔代码，5 表示排序代码为 5 号继电器。
- 3.3.2、电路图中编码为 KM/3 的继电器，K 表示外置继电器，K 表示地板线束，/表示分隔代码，3 表示排序代码为 3 号继电器

电路图册

电路图册说明	1	9、仪表板线束 I I	43
目录	1	10、地板线束	46
第一节 继电器、保险丝位置分布图	3	11、前舱线束	56
1、仪表板配电箱	3	12、蓄电池负极搭铁线束	66
2、前舱配电箱	6	13、主电机控制器外壳搭铁	69
第二节 整车线束图	10	14、高压配电箱搭铁线束	72
1、左前门线束	11	15、PTC 搭铁线束	75
2、左后门线束	14	16、电池加热器外壳搭铁线束	80
3、右前门线束	17	17、前电机总成搭铁线束	83
4、右后门线束	20	18、后风挡加热负极线	86
5、蓄电池正极线束	23	19、电池包搭铁线束	90
6、后保险杠线束	26	20、前保险杠小线	93
7、顶棚线束	29	21、2D 天线馈小线	96
8、仪表板线束 I	32	第四节 电器原理图	99

第一节 继电器、保险丝位置分布图

1、仪表板配电箱

1.1 仪表板配电箱总成接插件、继电器编号示意图

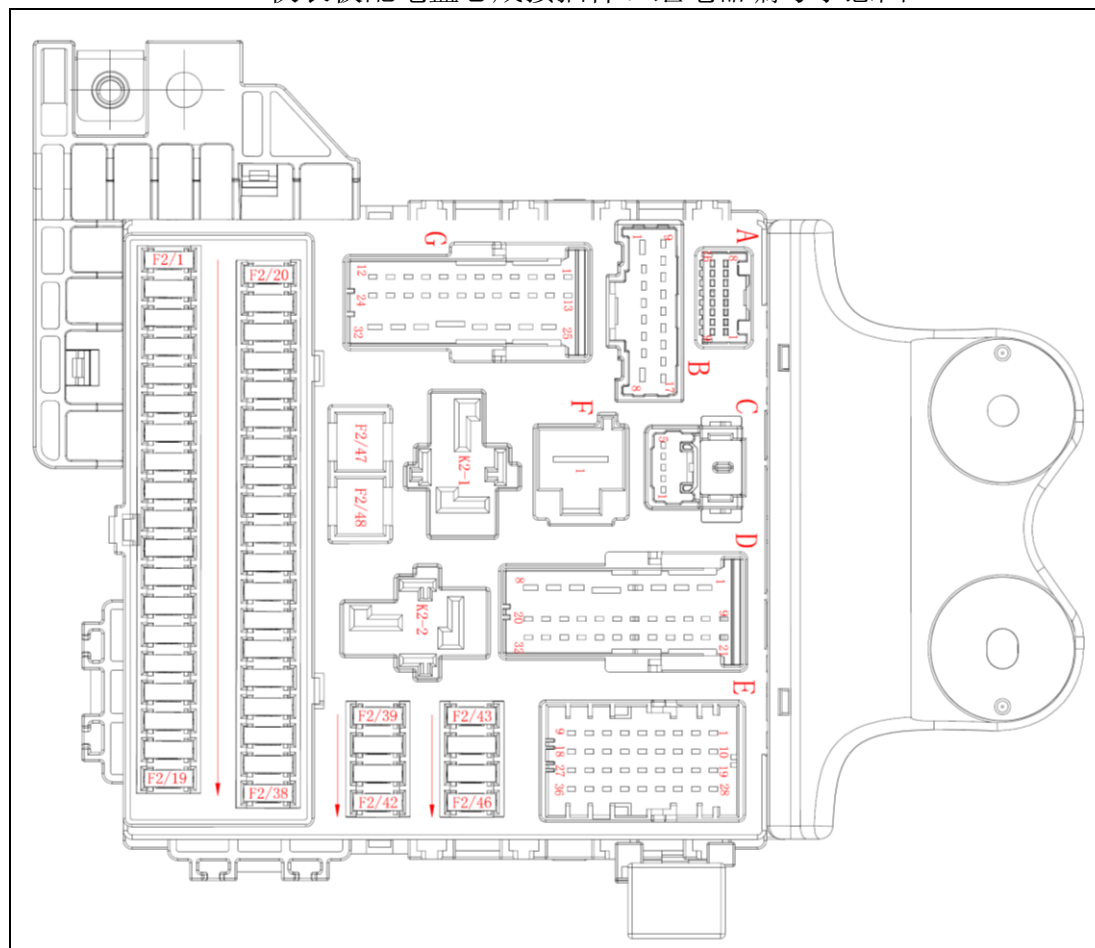

正面图

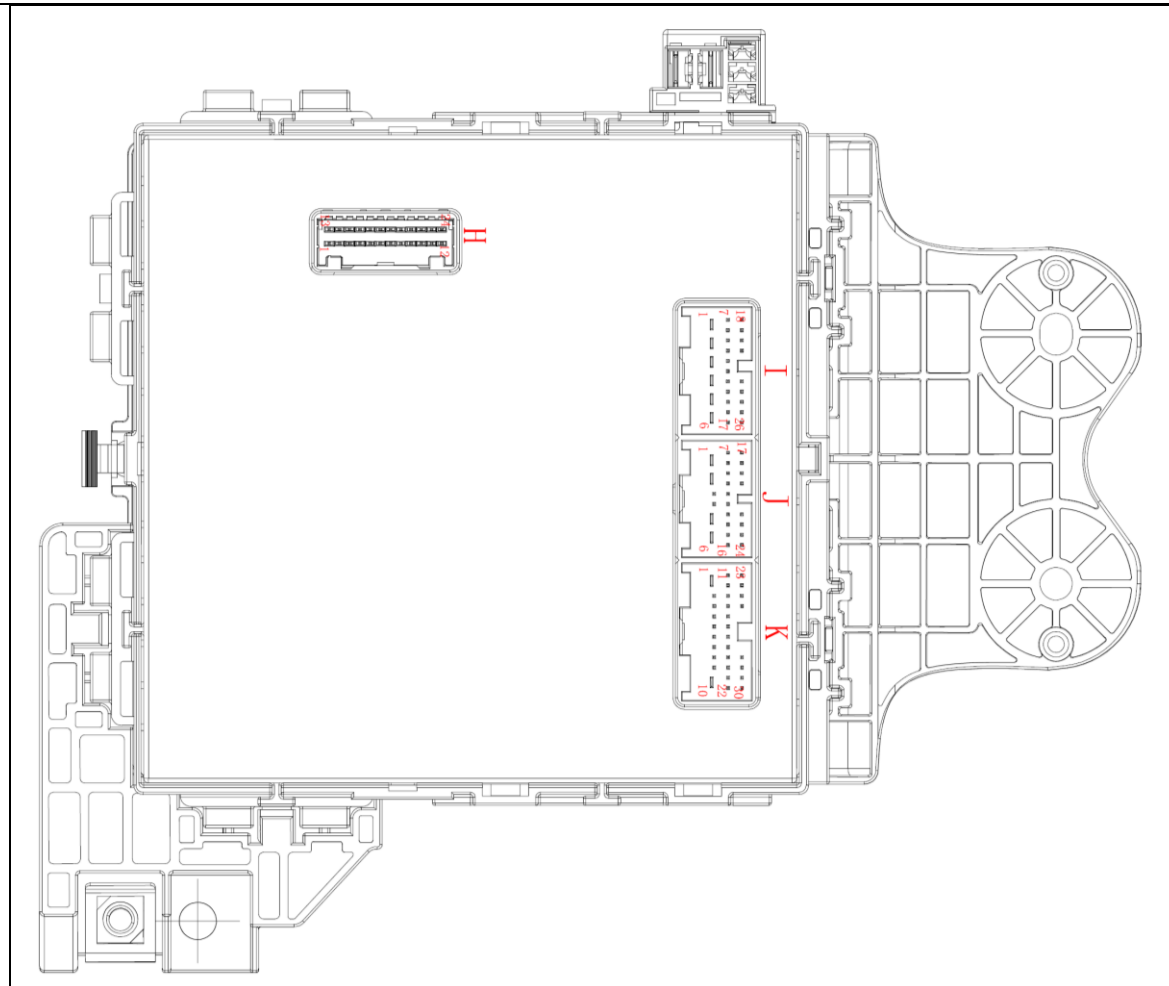

反面图



1.2. 保险编号示意图

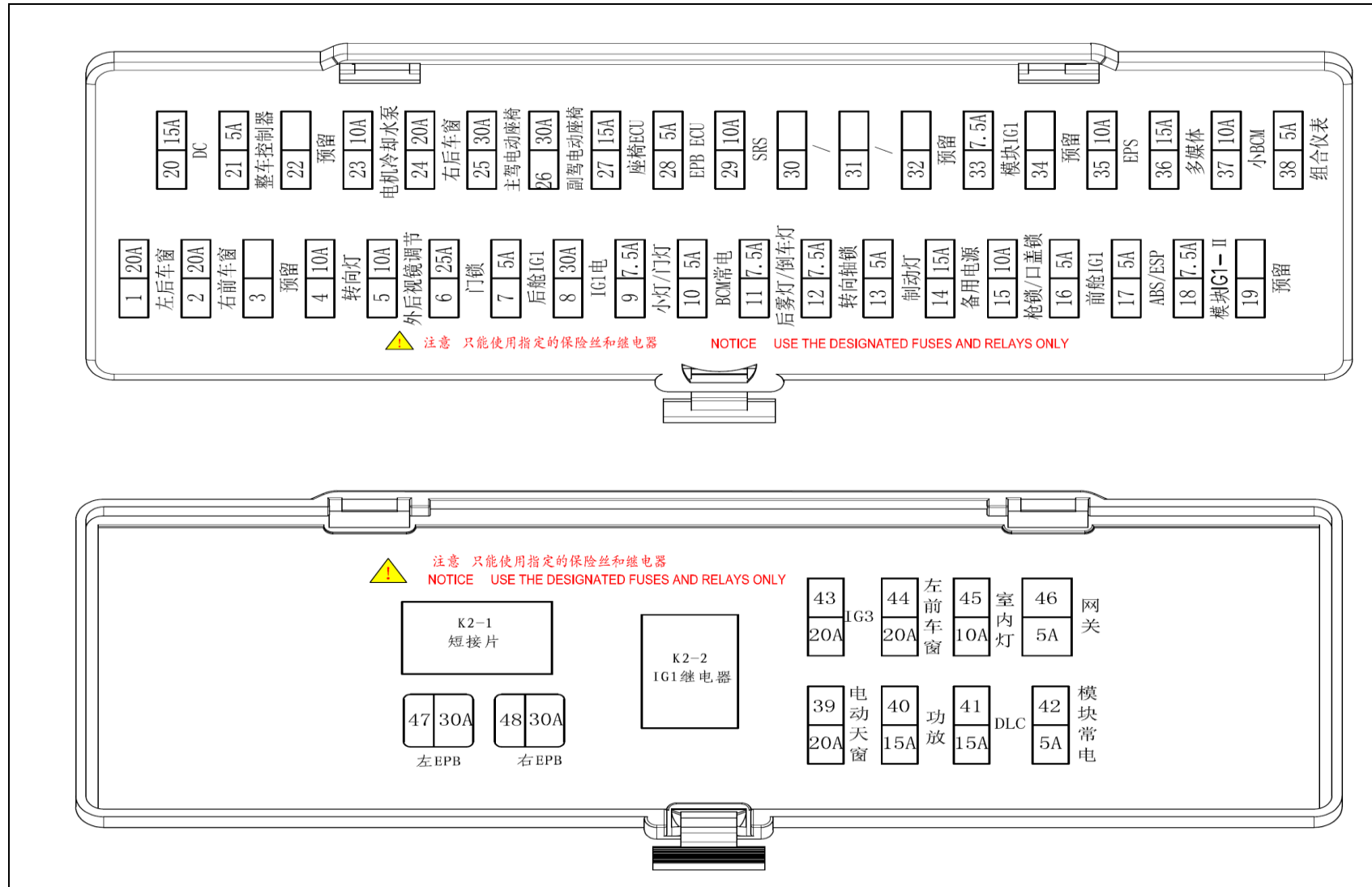

2、前舱配电箱

2.1 前舱配电箱总成保险、继电器编号示意图

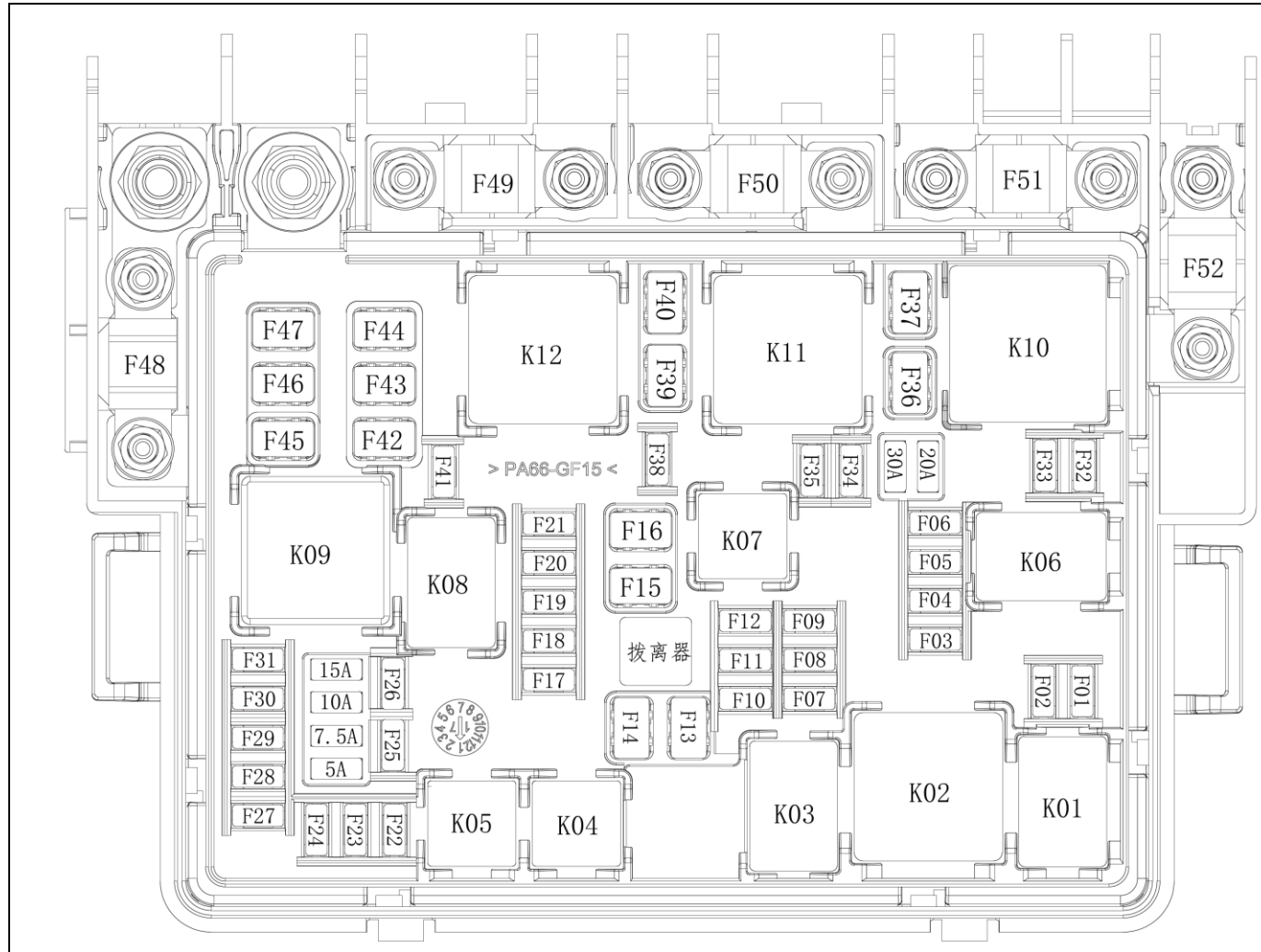

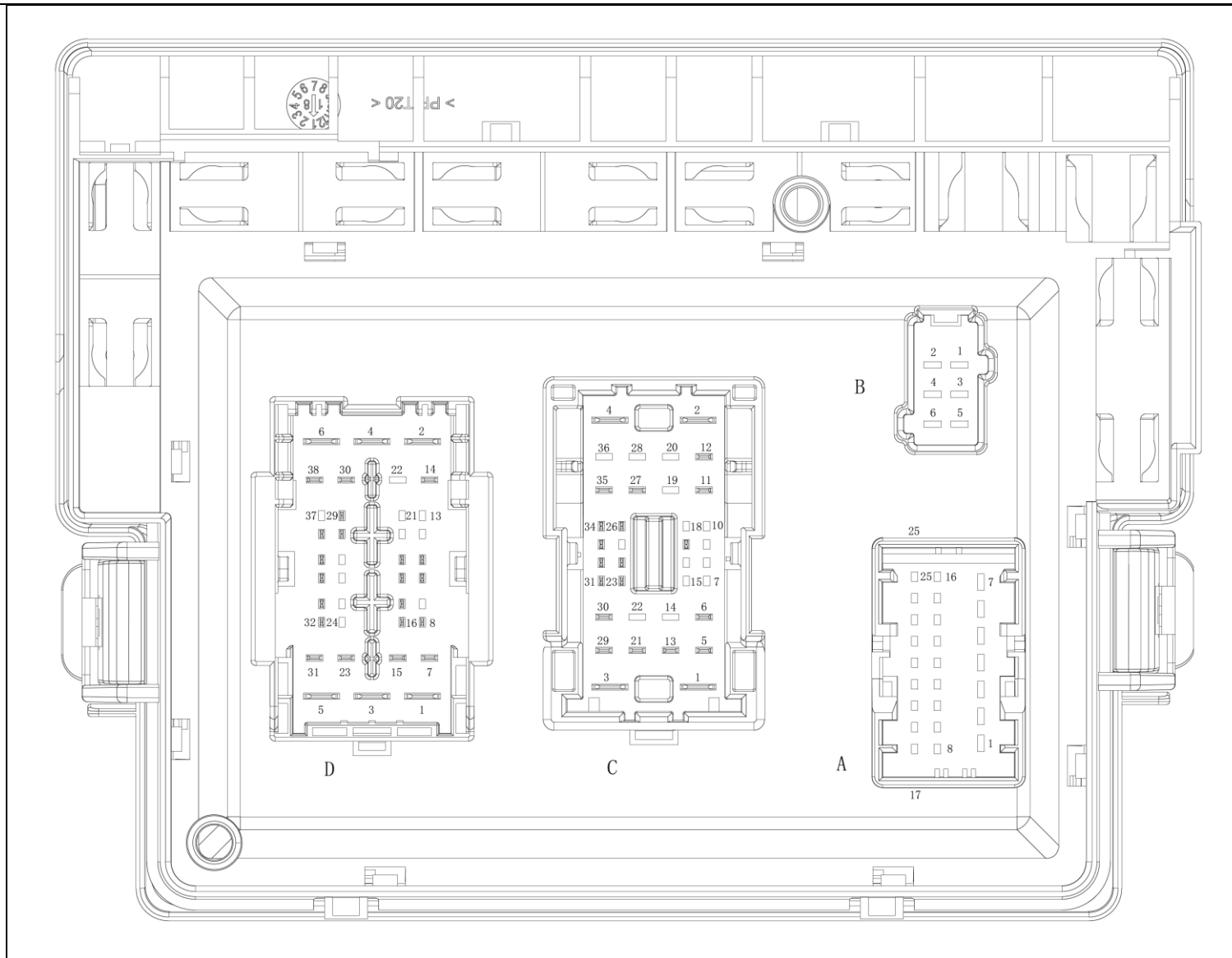



2.2 前舱配电箱总成保险、继电器规格

编号	规格	保险名称	编号	规格	保险名称	编号	规格	保险名称
F1/1	15A	左近光灯	F1/21		预留	F1/41		预留
F1/2	15A	右近光灯	F1/22	5A	充配电总成	F1/42		/
F1/3	5A	昼行灯	F1/23	25A	燃油加热器	F1/43	30A	雨刮
F1/4	5A	高压 BMS	F1/24		/	F1/44	40A	真空泵 2
F1/5	5A	EVP 检测	F1/25		预留	F1/45		/
F1/6		预留	F1/26		预留	F1/46		/
F1/7	10A	电池冷却水泵	F1/27		/	F1/47		/
F1/8	7.5A	电动压缩机	F1/28		/	F1/48	200A	电池
F1/9	10A	洗涤电机	F1/29		/	F1/49		预留
F1/10	7.5A	空调 ECU	F1/30		/	F1/50	80A	仪表板配电箱
F1/11	10A	电机冷却水泵	F1/31		/	F1/51	70A	CEPS
F1/12	5A	整车控制器	F1/32	15A	左远光灯	F1/52		预留
F1/13	40A	鼓风机	F1/33	15A	右远光灯			
F1/14	30A	后除霜	F1/34	10A	DC			
F1/15		预留	F1/35		/			
F1/16		预留	F1/36	40A	ABS/ESP			
F1/17	10A	喇叭	F1/37	40A	真空泵 1			
F1/18	5A	暖风水泵	F1/38		预留			
F1/19		预留	F1/39	25A	ABS/ESP			
F1/20		预留	F1/40	40A	风扇			



电路图册

编号	型号	继电器名称	编号	型号	继电器名称
K1-1	MICRO	近光灯继电器	K1-22	PCB 式	雨刮速度调节继电器
K1-2	MINI	高速风扇继电器	K1-23	PCB 式	雨刮开关继电器
K1-3	MICRO	IG4 继电器			
K1-4		/			
K1-5		/			
K1-6	MICRO	远光灯继电器			
K1-7	U-MICRO	IG3 继电器			
K1-8	MICRO	预留			
K1-9		/			
K1-10	SSR	真空泵继电器 1			
K1-11	MINI	低速风扇继电器			
K1-12	MINI	真空泵继电器 2			
K1-13	PCB 式	后除霜继电器			
K1-14	PCB 式	喇叭继电器			
K1-15	PCB 式	暖风水泵继电器			
K1-16	PCB 式	预留			
K1-17		/			
K1-18	PCB 式	昼行灯继电器			
K1-19	PCB 式	前洗涤继电器			
K1-20	PCB 式	预留			
K1-21		/			

第二节 整车线束图

电路图册

1、左前门线束

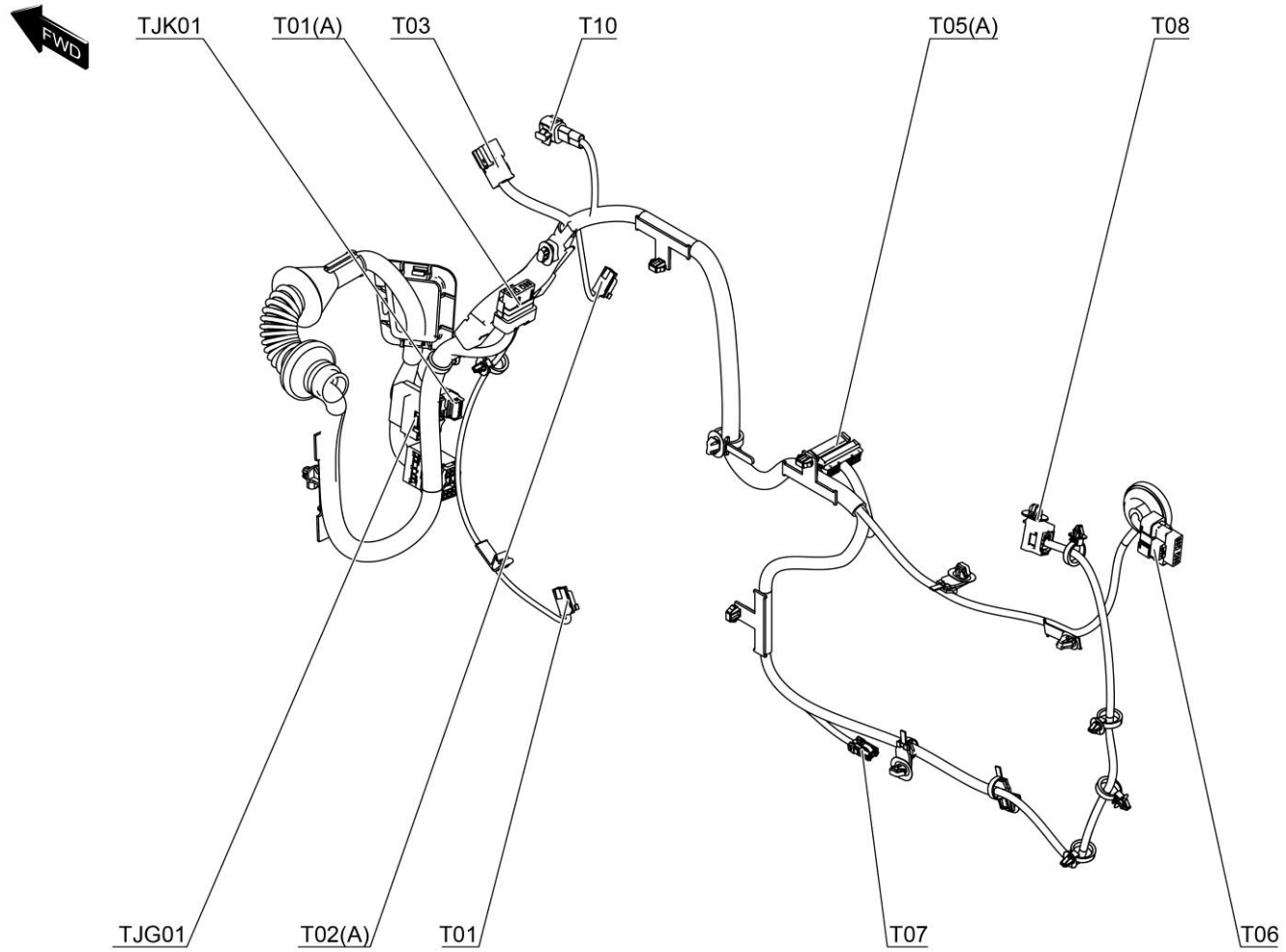



图					
序号 No.	零件编号 Part No.	名 称 Description		数量 Qty	备注 Rem
		中 文 Chinese	英 文 English		
01	TJK01	接地板线束			
02	T01(A)	接左前玻璃升降电机(防夹)			
03	T03	接左前门外后视镜			
04	T10	接左前高音扬声器			
05	T05(A)	接左前玻璃升降器 A 口			
06	T08	接左前门车外探测天线			
07	T06	接左前门锁电机			
08	T07	接左前门灯			
09	T01	接左前玻璃升降电机(非防夹)			
10	T02(A)	接左前门低音扬声器			
11	TJG01	接仪表线束			

2、左后门线束



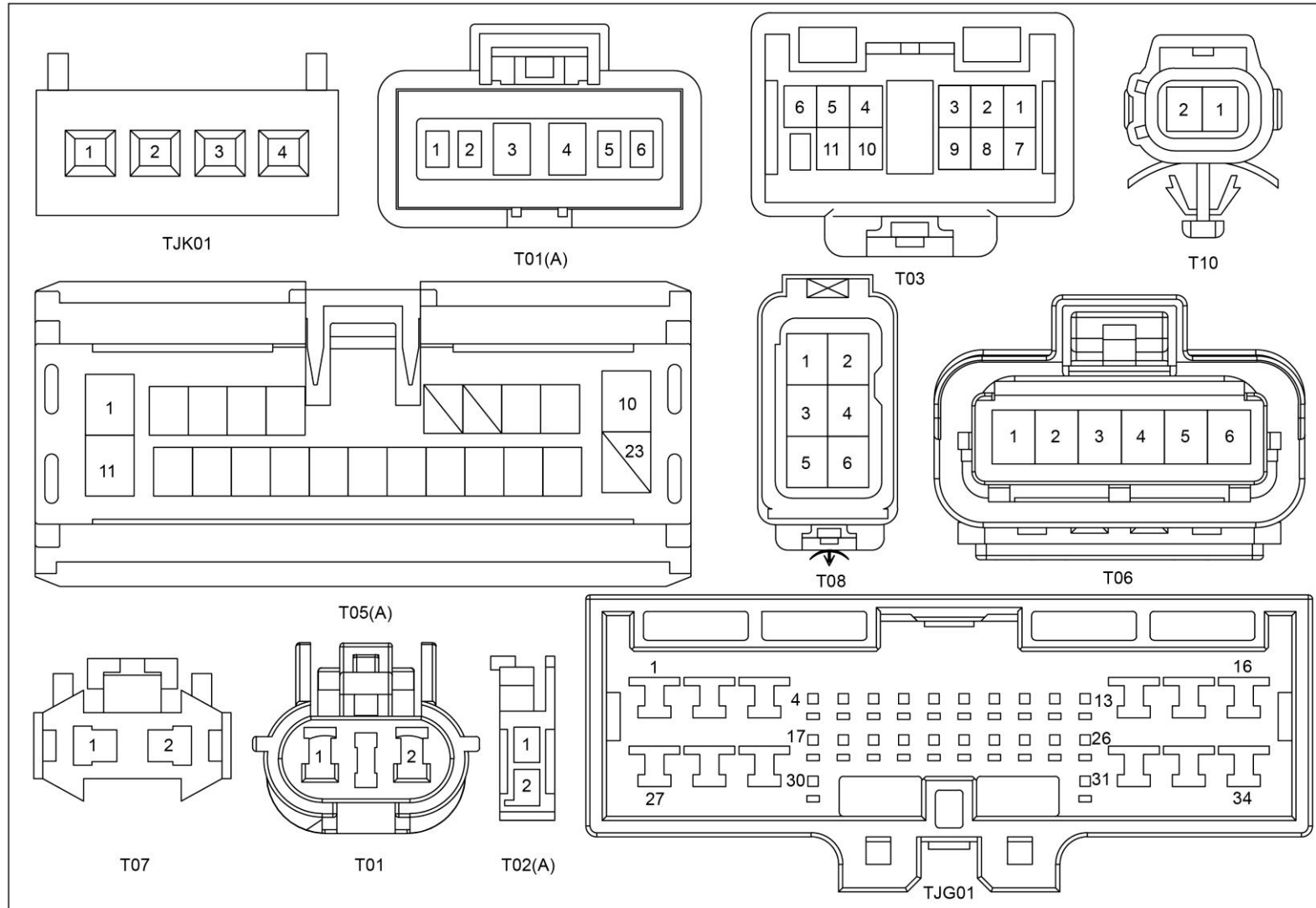
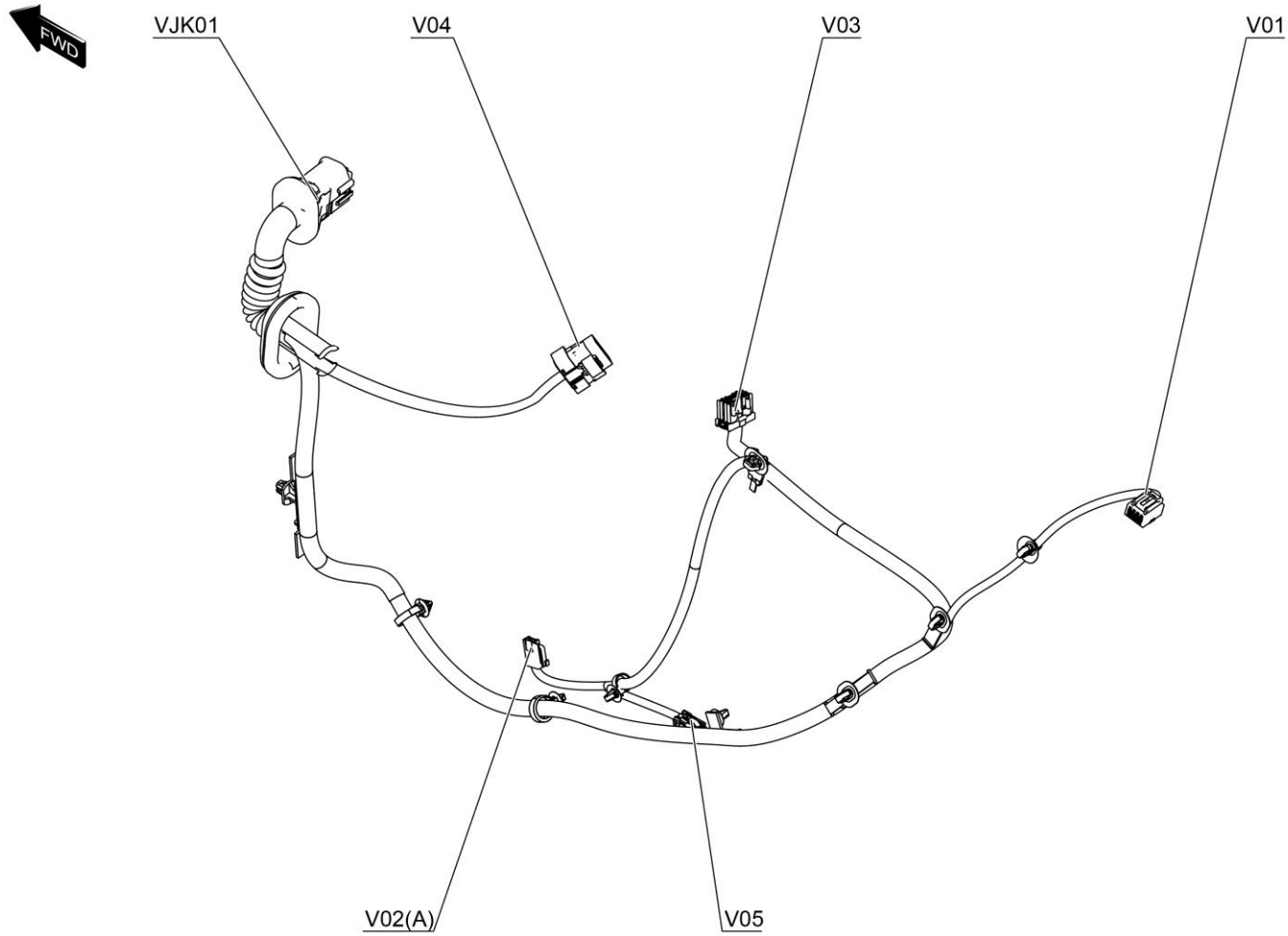

图					
序号 No.	零件编号 Part No.	名 称 Description		数量 Qty	备注 Rem
		中 文 Chinese	英 文 English		
01	VJK01	接地板线束			
02	V04	接左后门锁电机			
03	V03	接左后玻璃升降器开关			
04	V01	接左后玻璃升降电机			
05	V05	接左后门灯			
06	V02(A)	接左后门低音扬声器			

3、右前门线束



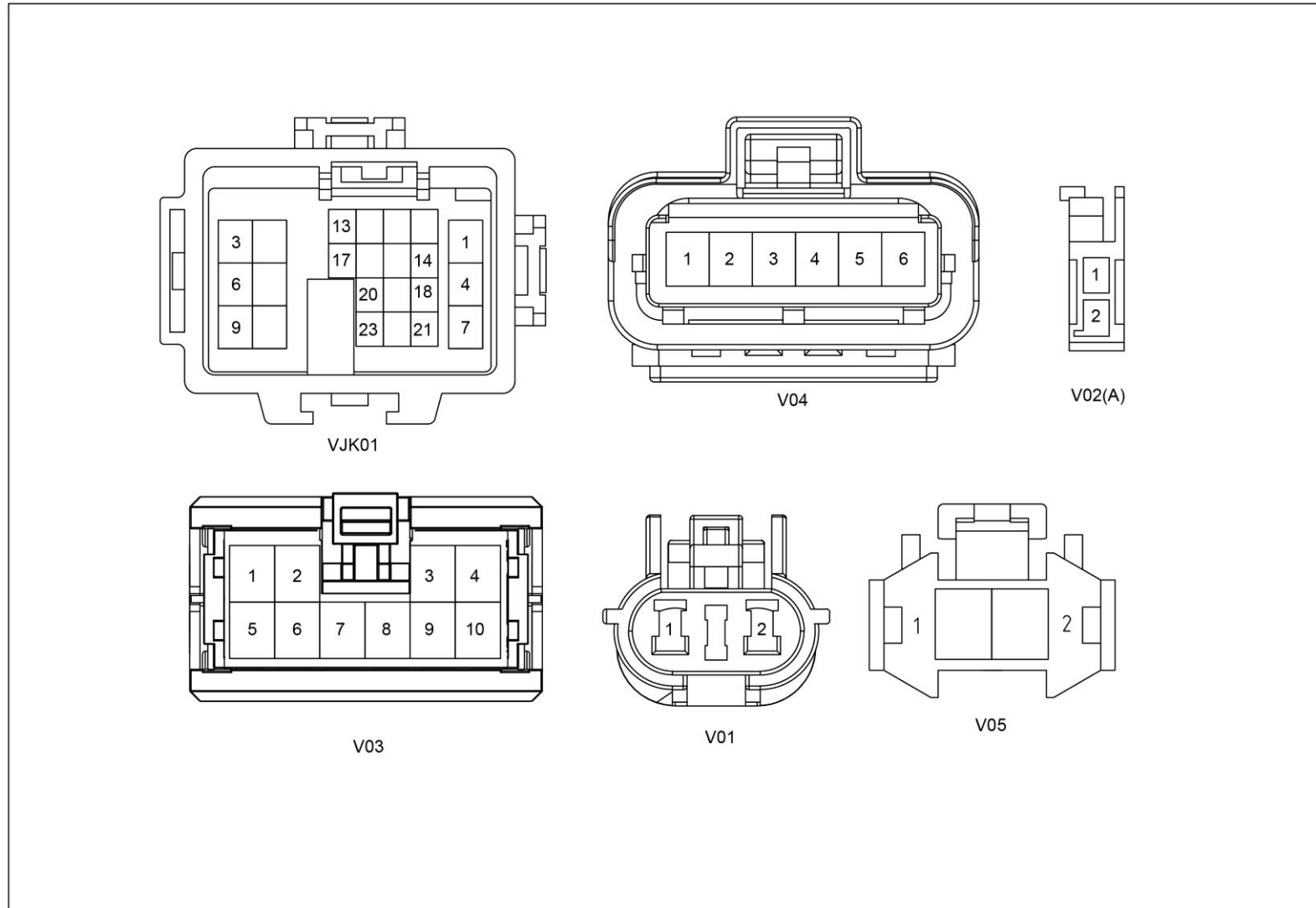
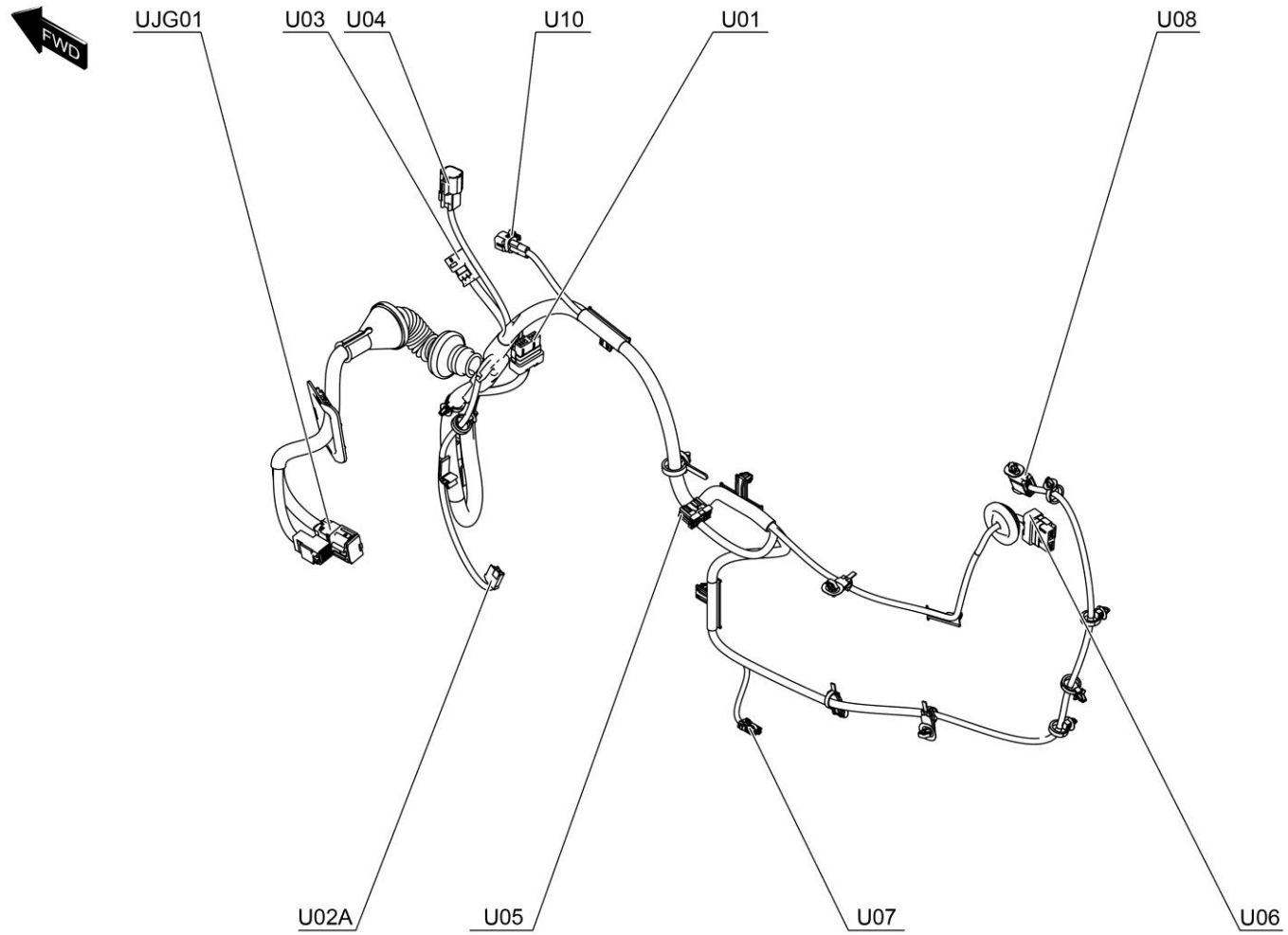

图					
序号 No.	零件编号 Part No.	名 称 Description		数量 Qty	备注 Rem
		中 文 Chinese	英 文 English		
01	UJG01	接仪表盘线束			
02	U03	接右前门外后视镜			
03	U04	接右前摄像头			
04	U10	接右前高音扬声器			
05	U01	接右前玻璃升降电机			
06	U08	接右前门车外探测天线			
07	U06	接右前门锁电机			
08	U07	接右前门灯			
09	U05	接右前玻璃升降器开关			
10	U02A	接右前门低音扬声器			

4. 右后门线束



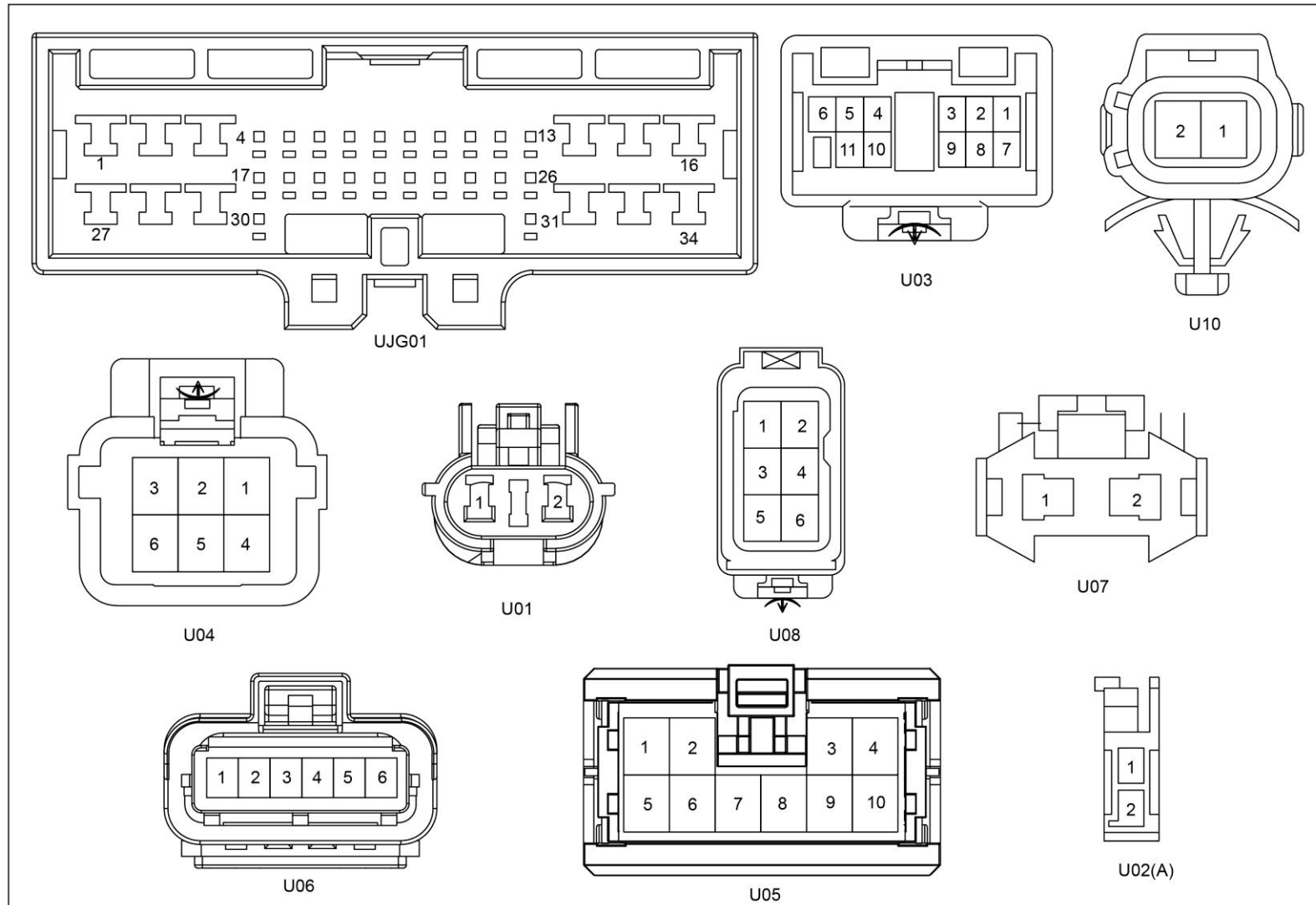
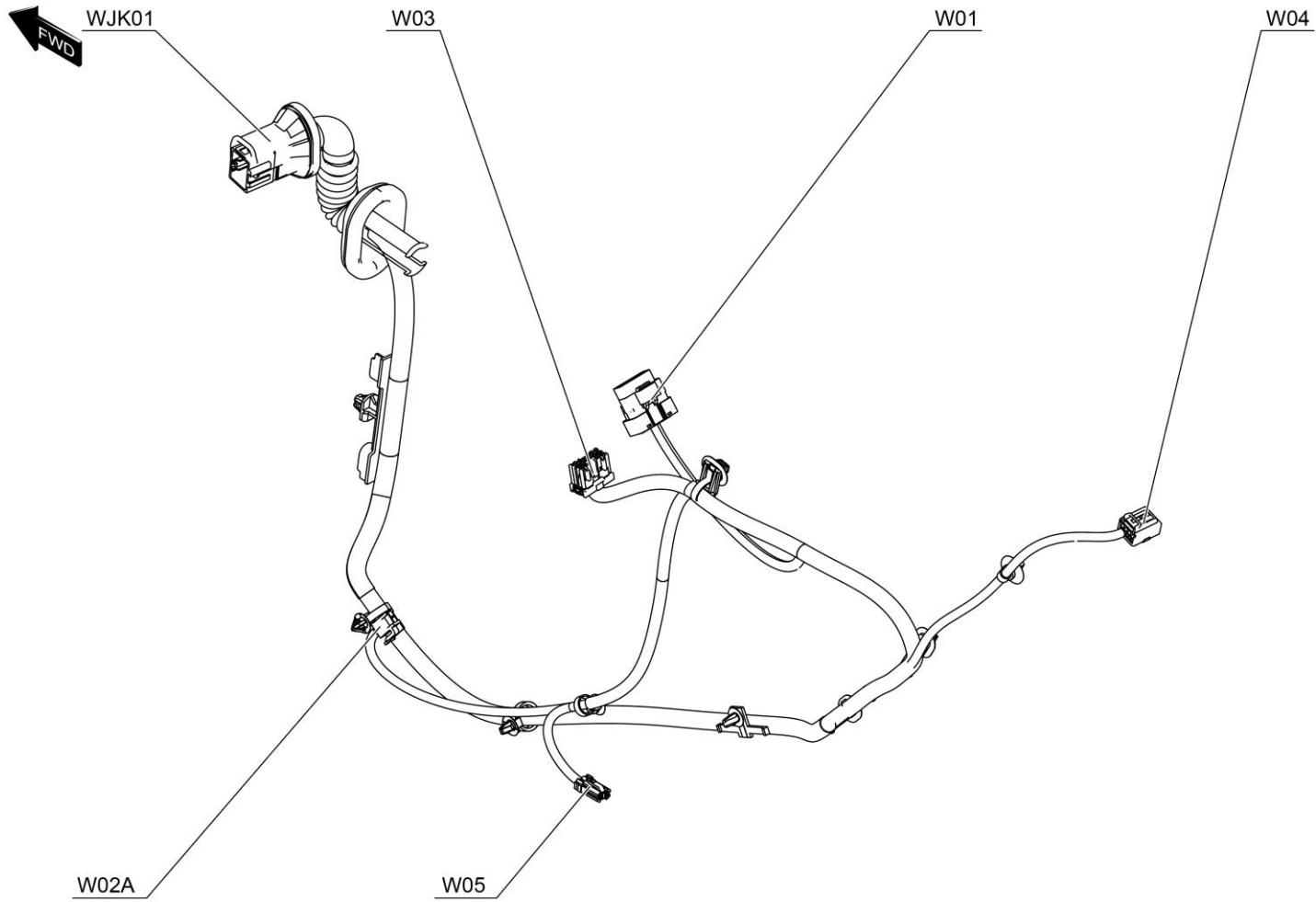
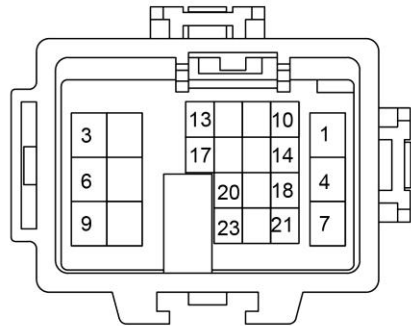

WJK01

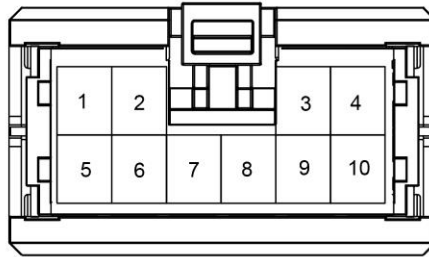

W03

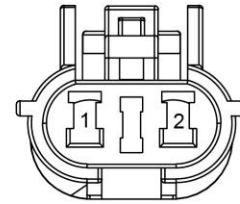

W01

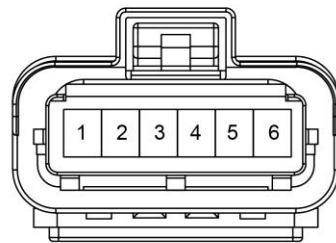

W04

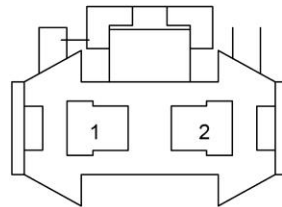

W05

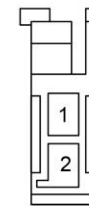

W02A

图					
序号 No.	零件编号 Part No.	名 称 Description		数量 Qty	备注 Rem
		中 文 Chinese	英 文 English		
01	WJK01	接地板线束			
02	W03	接右后门玻璃升降器开关			
03	W01	接右后玻璃升降电机			
04	W04	接右后门锁电机			
05	W05	接右后门灯			
06	W02A	接右后门低音扬声器			

5、蓄电池正极线束

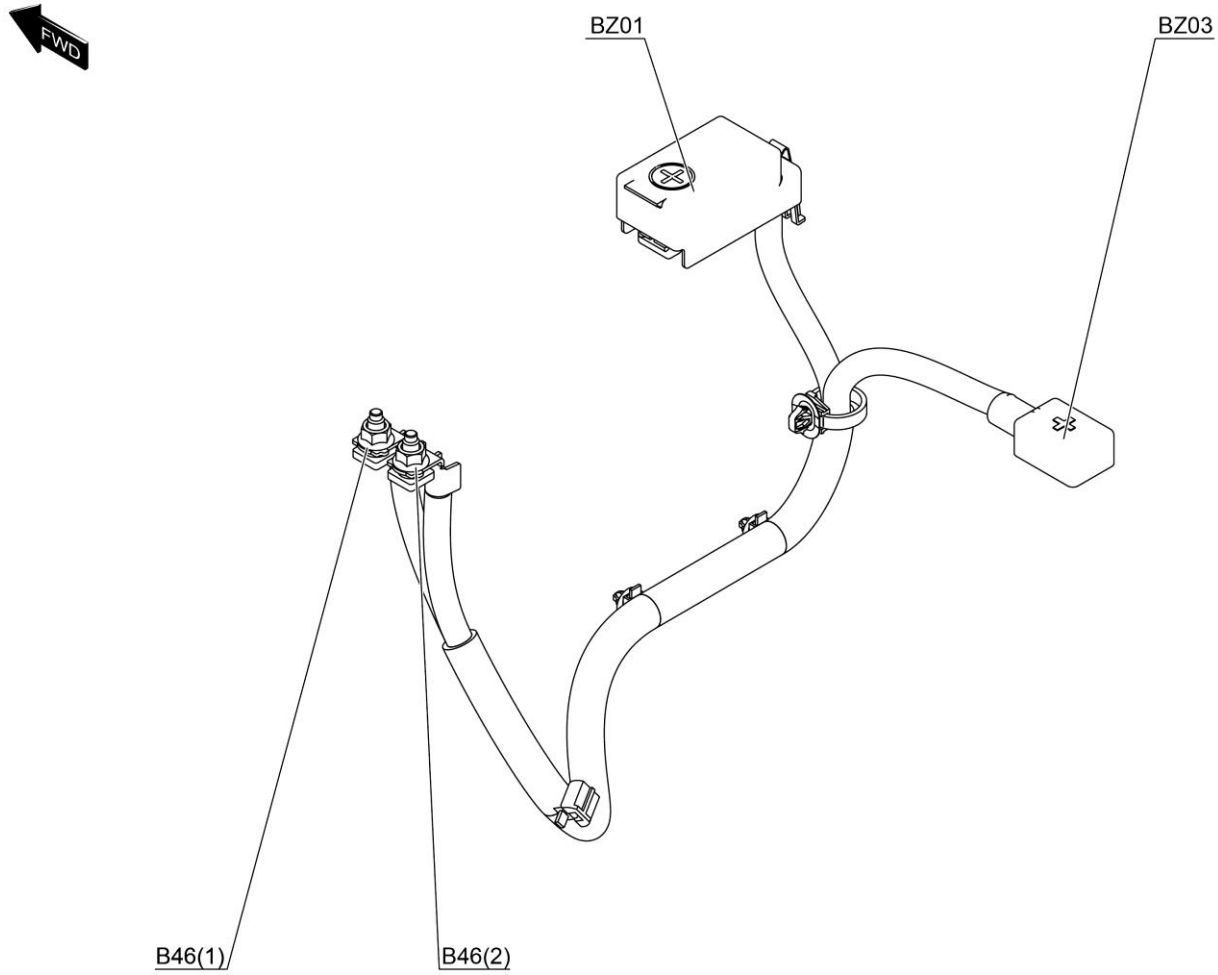



图					
序号 No.	零件编号 Part No.	名 称 Description		数量 Qty	备注 Rem
		中 文 Chinese	英 文 English		
01	BZ01	接蓄电池正极			
02	BZ03	接 DC 正极			
03	B46(2)	接前舱配电箱 2# 口(DC 正极)			
04	B46(1)	接前舱配电箱 2# 口(蓄电池)			

6、后保险杠线束



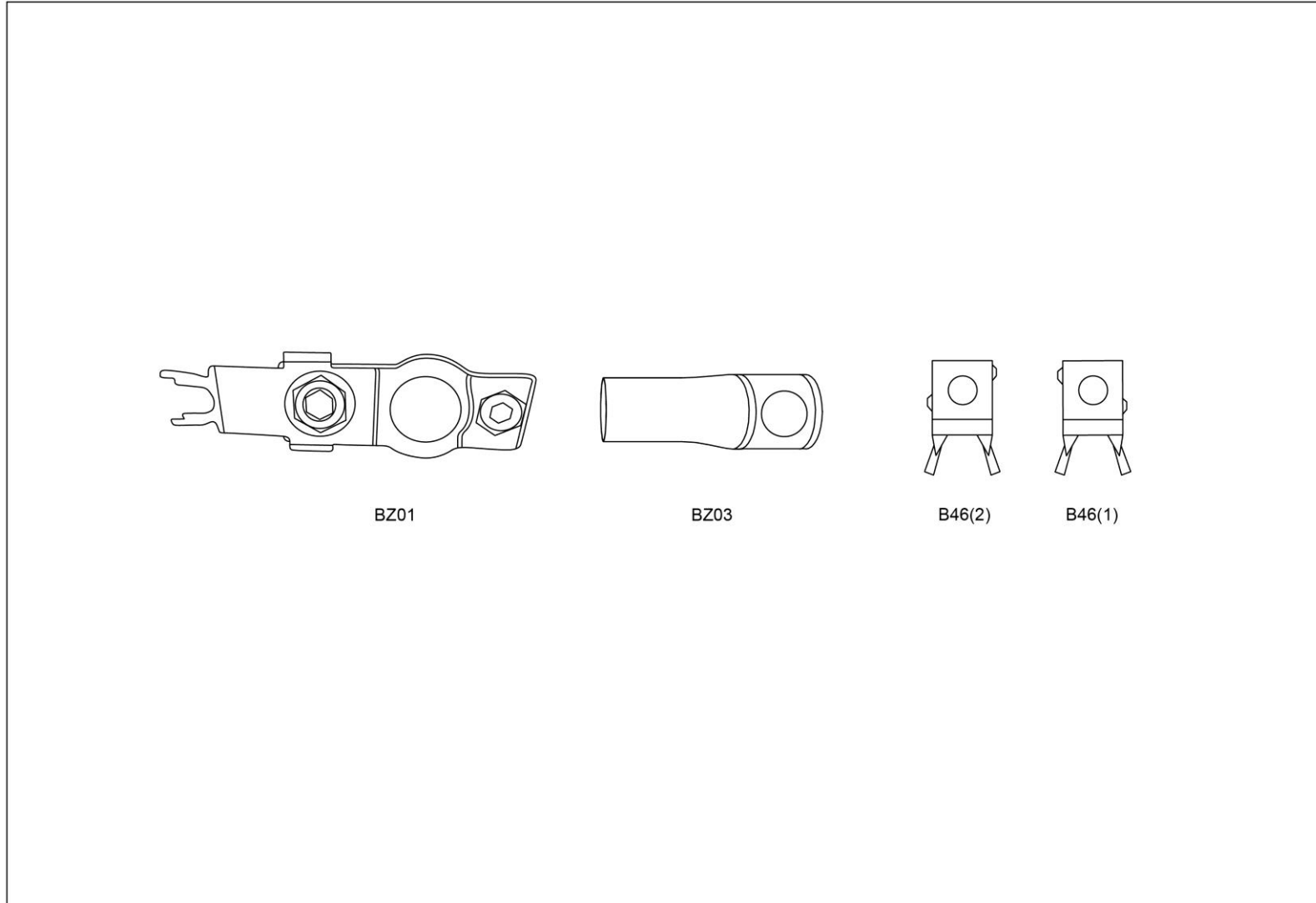
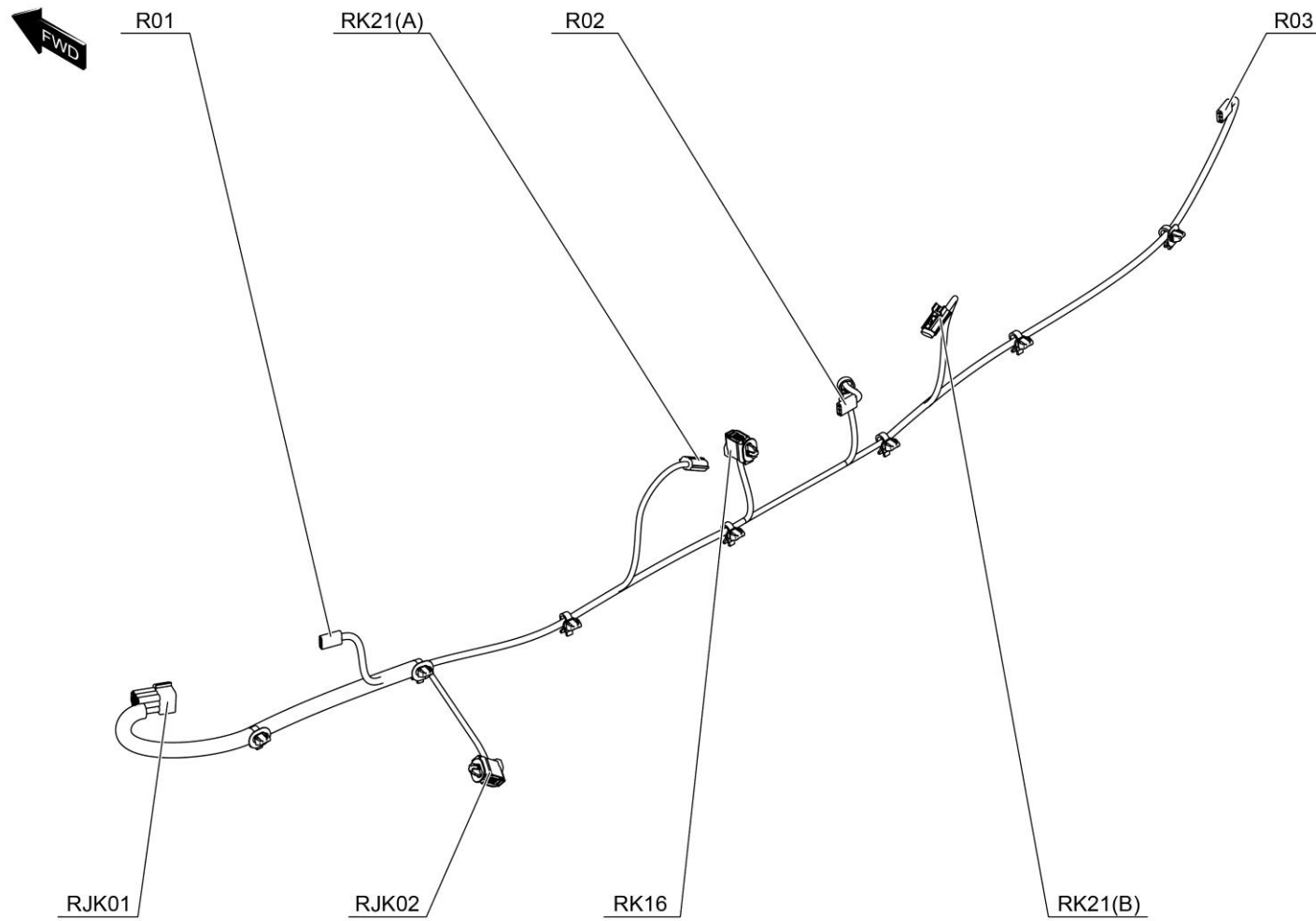

图					
序号 No.	零件编号 Part No.	名 称 Description		数量 Qty	备注 Rem
		中 文 Chinese	英 文 English		
01	R01	接左后间隙传感器			
02	RK21(A)	接左牌照灯			
03	R02	接中后间隙传感器			
04	R03	接右后间隙传感器			
05	RK21(B)	接右牌照灯			
06	RK16	接倒车摄像头			
07	RJK02	接地板线束 2			
08	RJK01	接地板线束 1			

7、顶棚线束



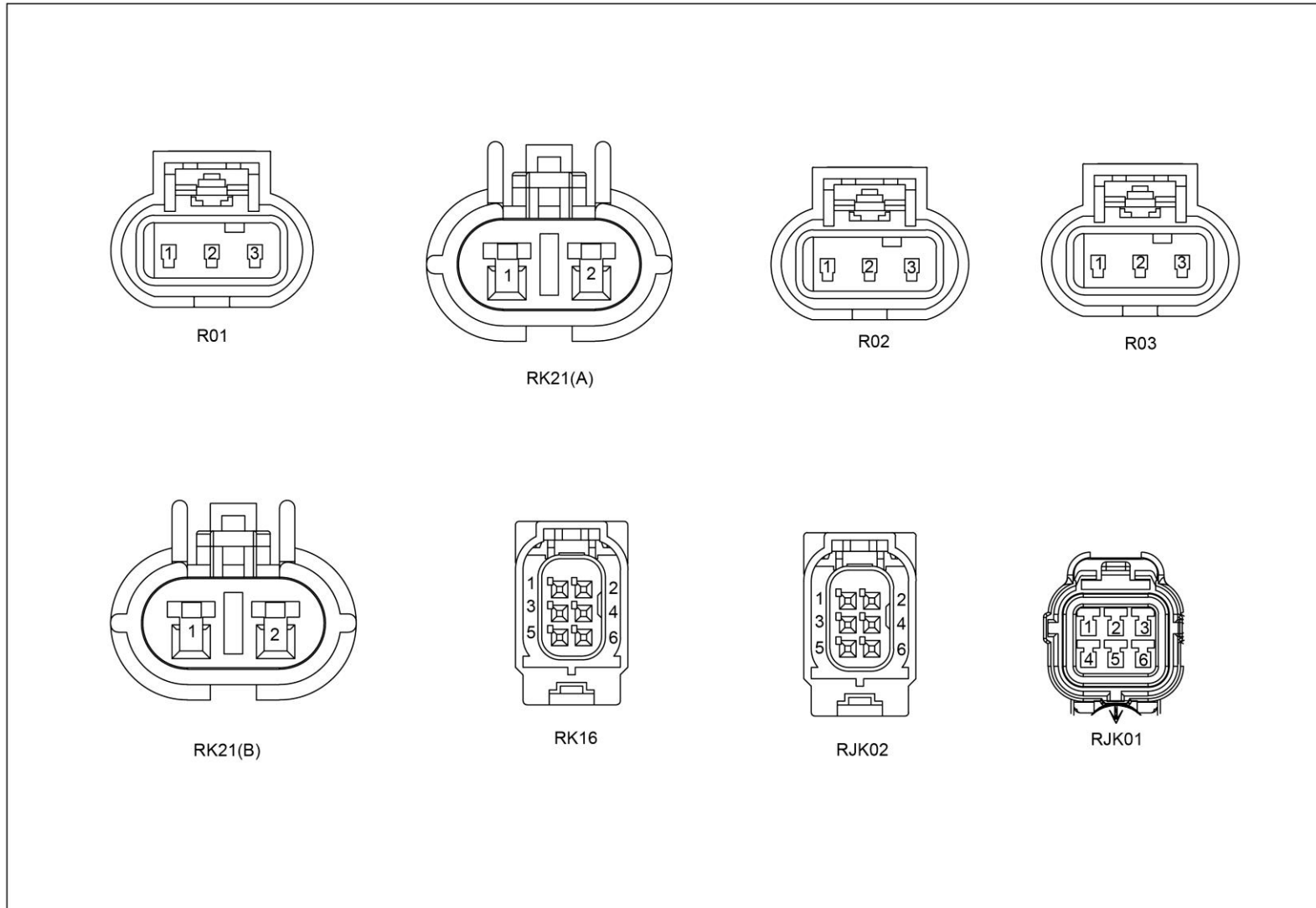
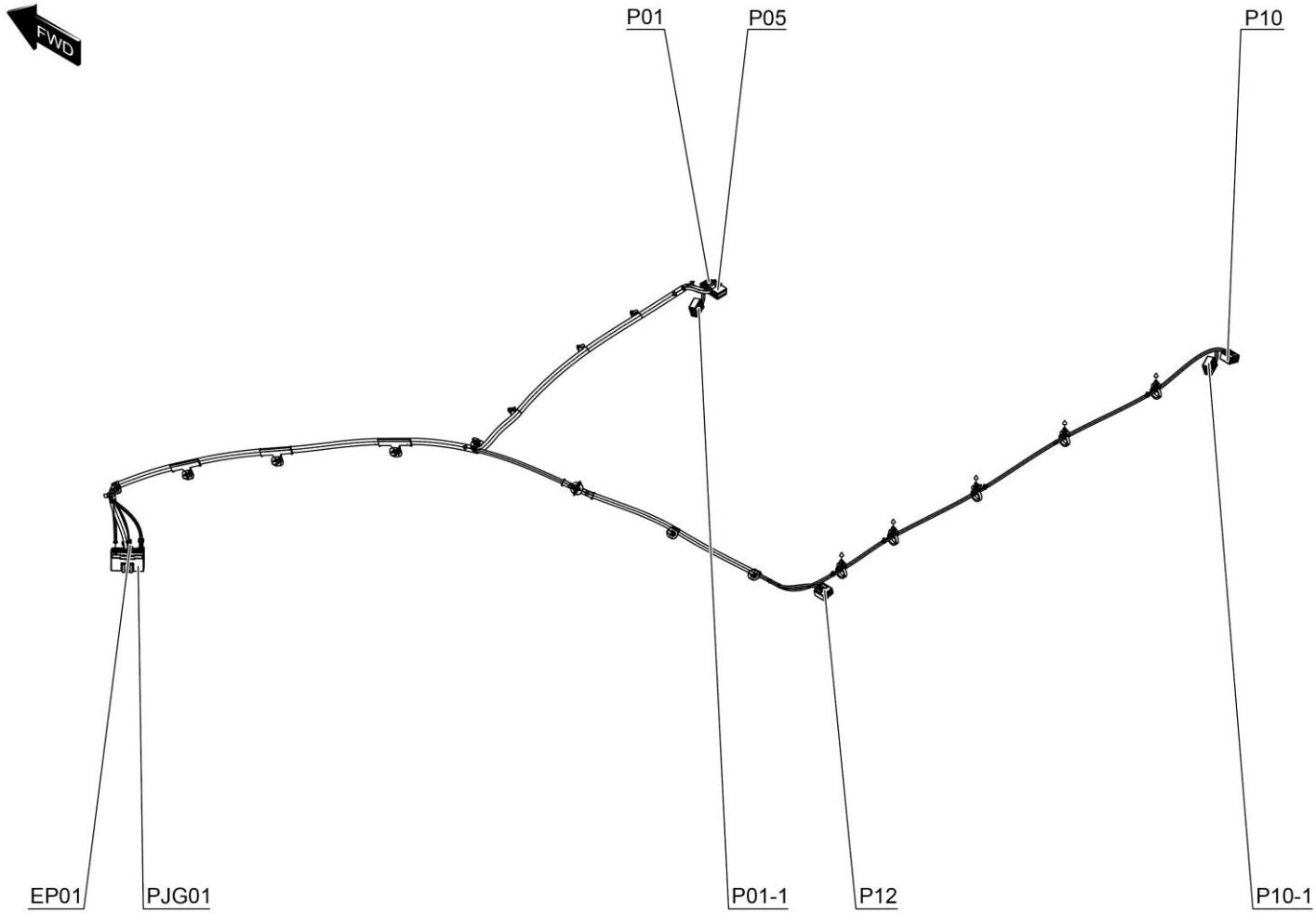

图					
序号 No.	零件编号 Part No.	名 称 Description		数量 Qty	备注 Rem
		中 文 Chinese	英 文 English		
01	P01	接前室内灯			
02	P05	接天窗电机			
03	P10	接后室内灯			
04	P10-1	接后室内灯(出租)			
05	P12	接出租车小线预留 2			
06	P01-1	接前室内灯(出租)			
07	EP01	顶棚接地			
08	PJG01	接仪表线束 I			

电路图册

8、仪表板线束 I



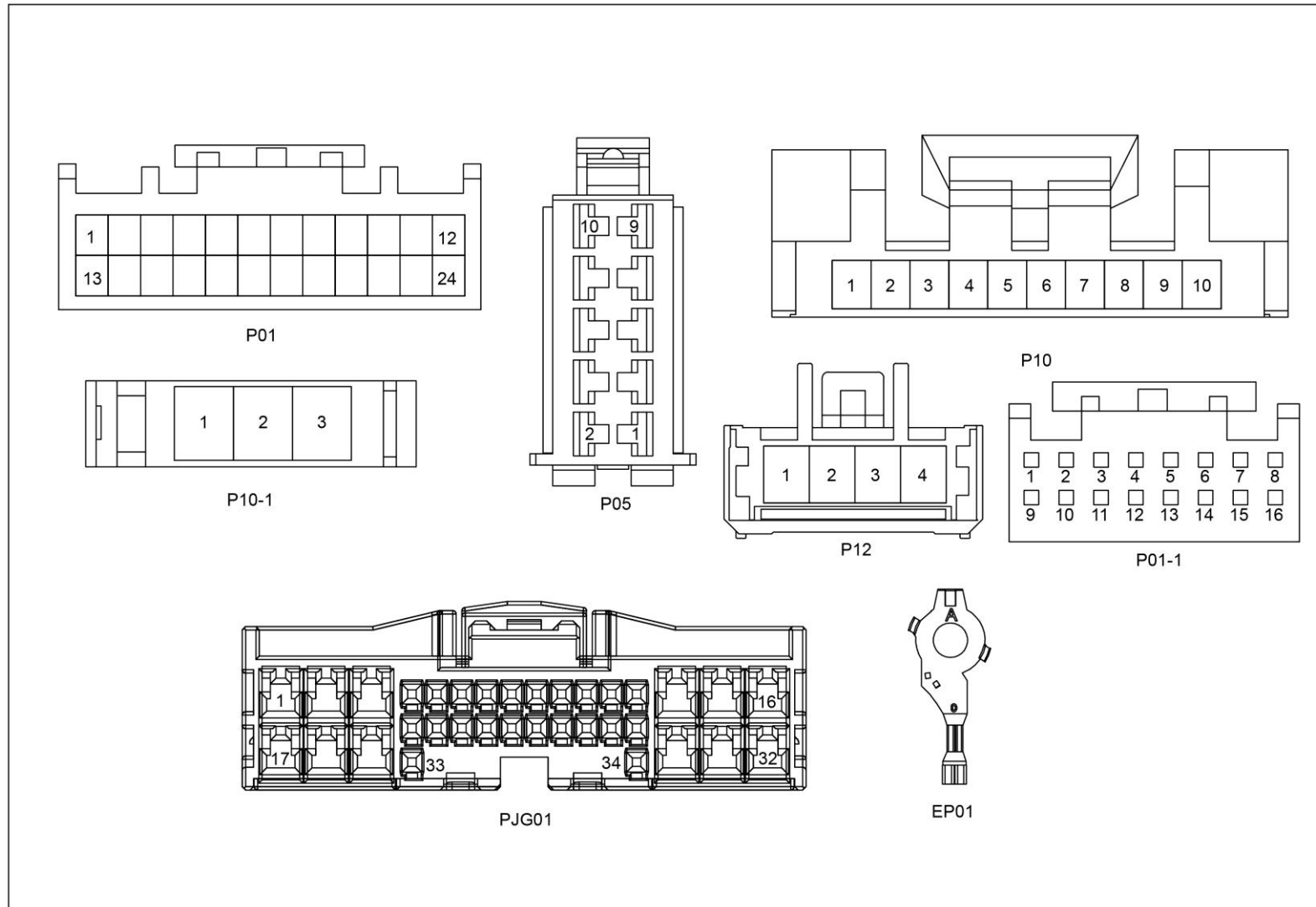
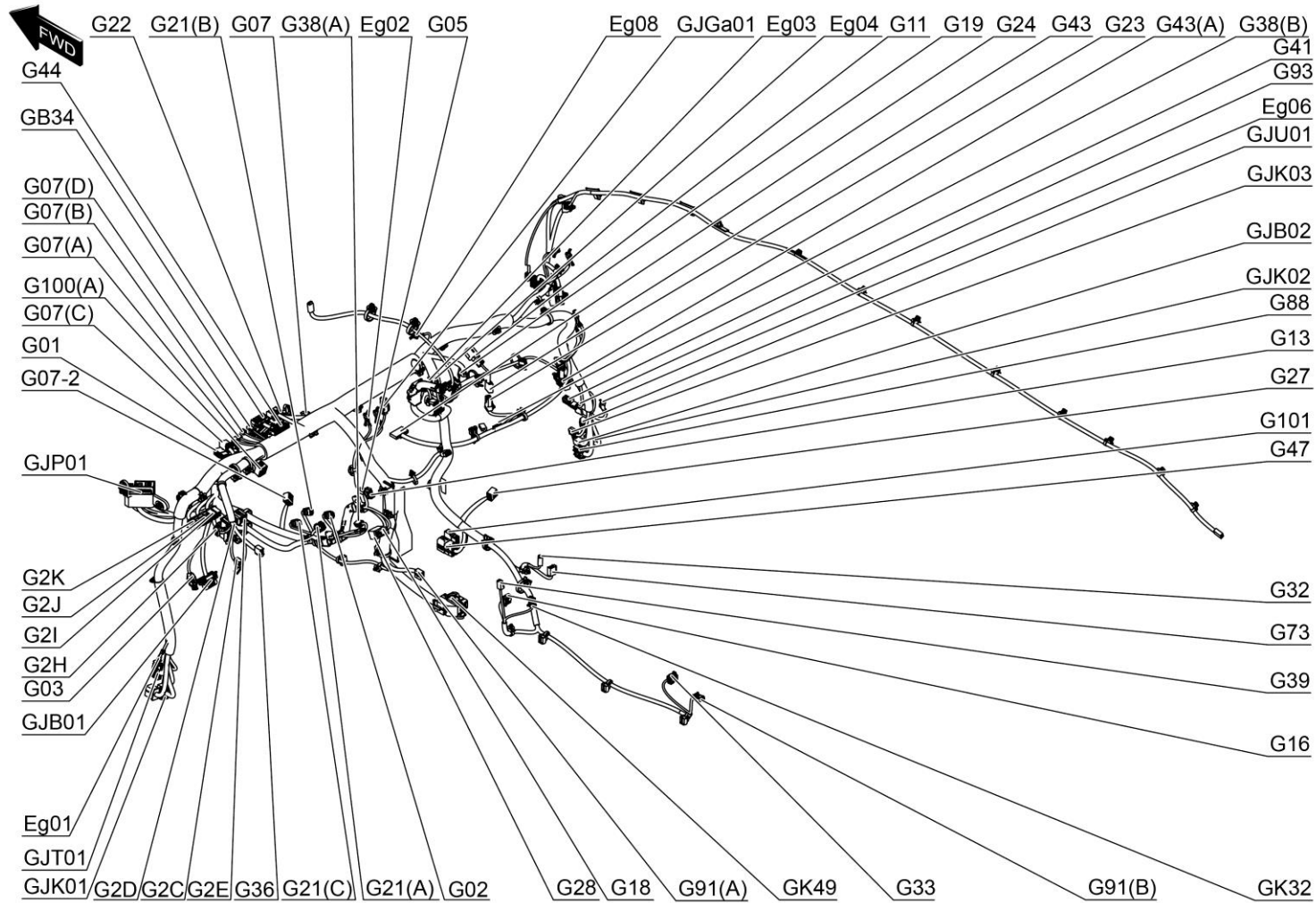
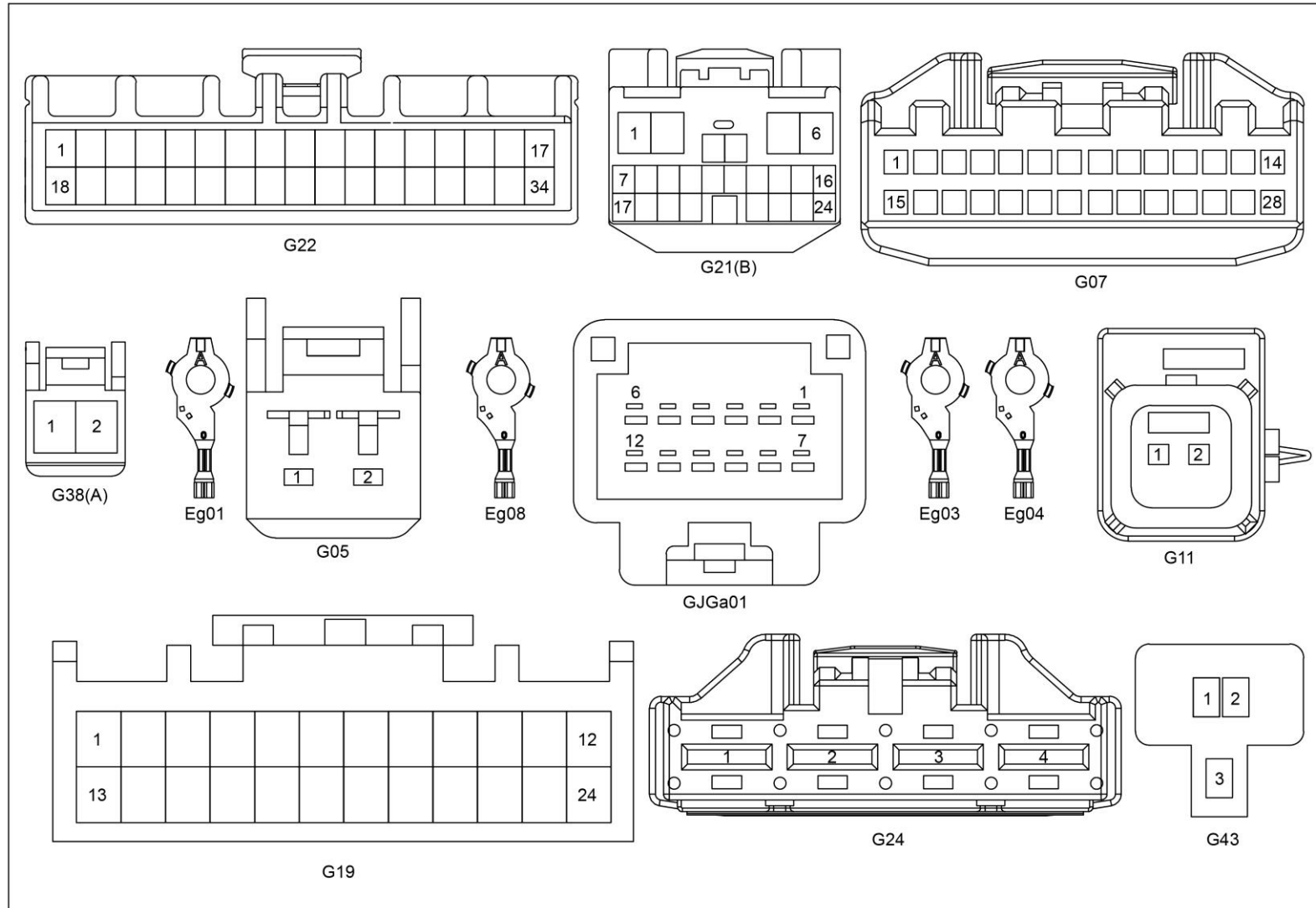

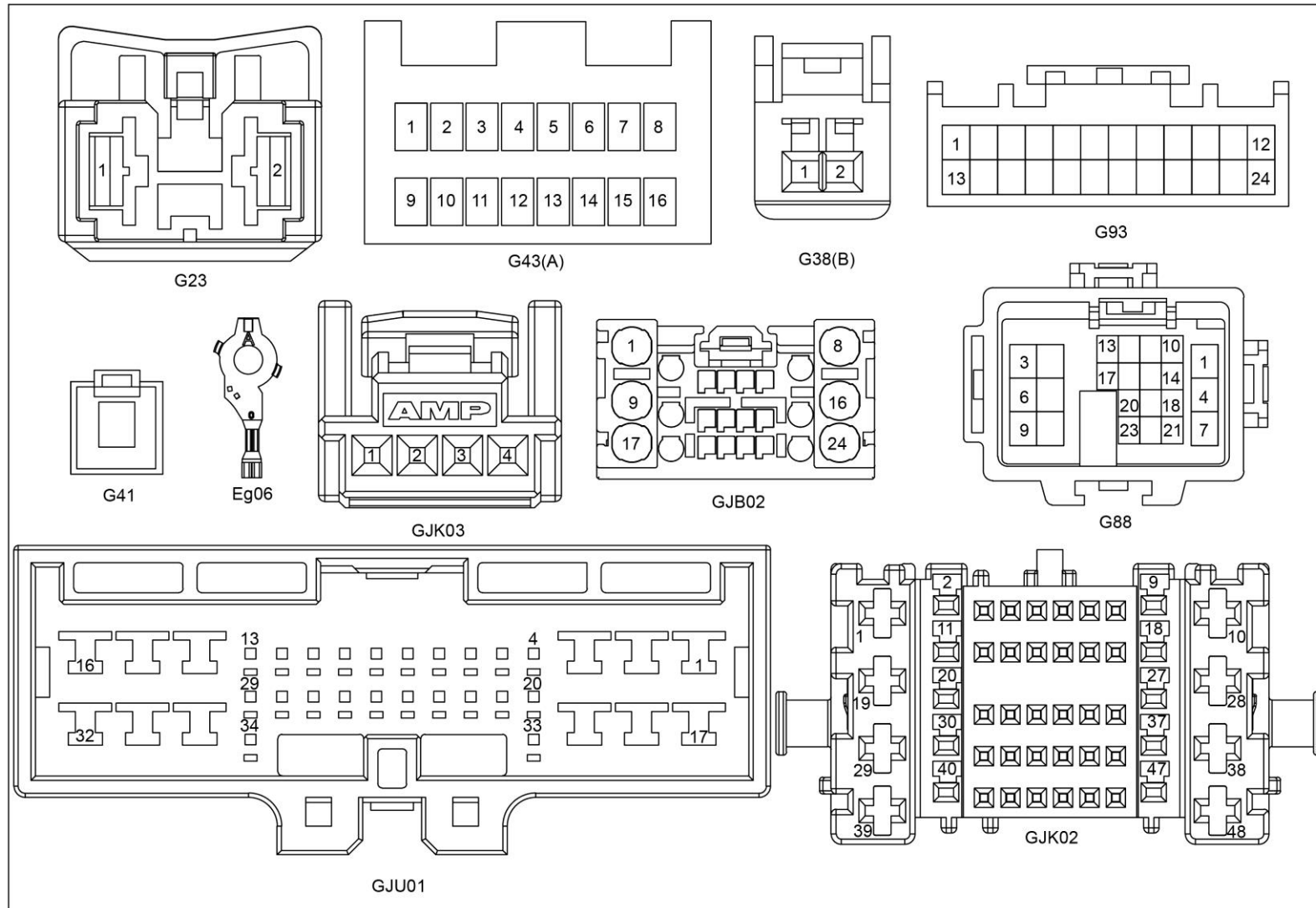

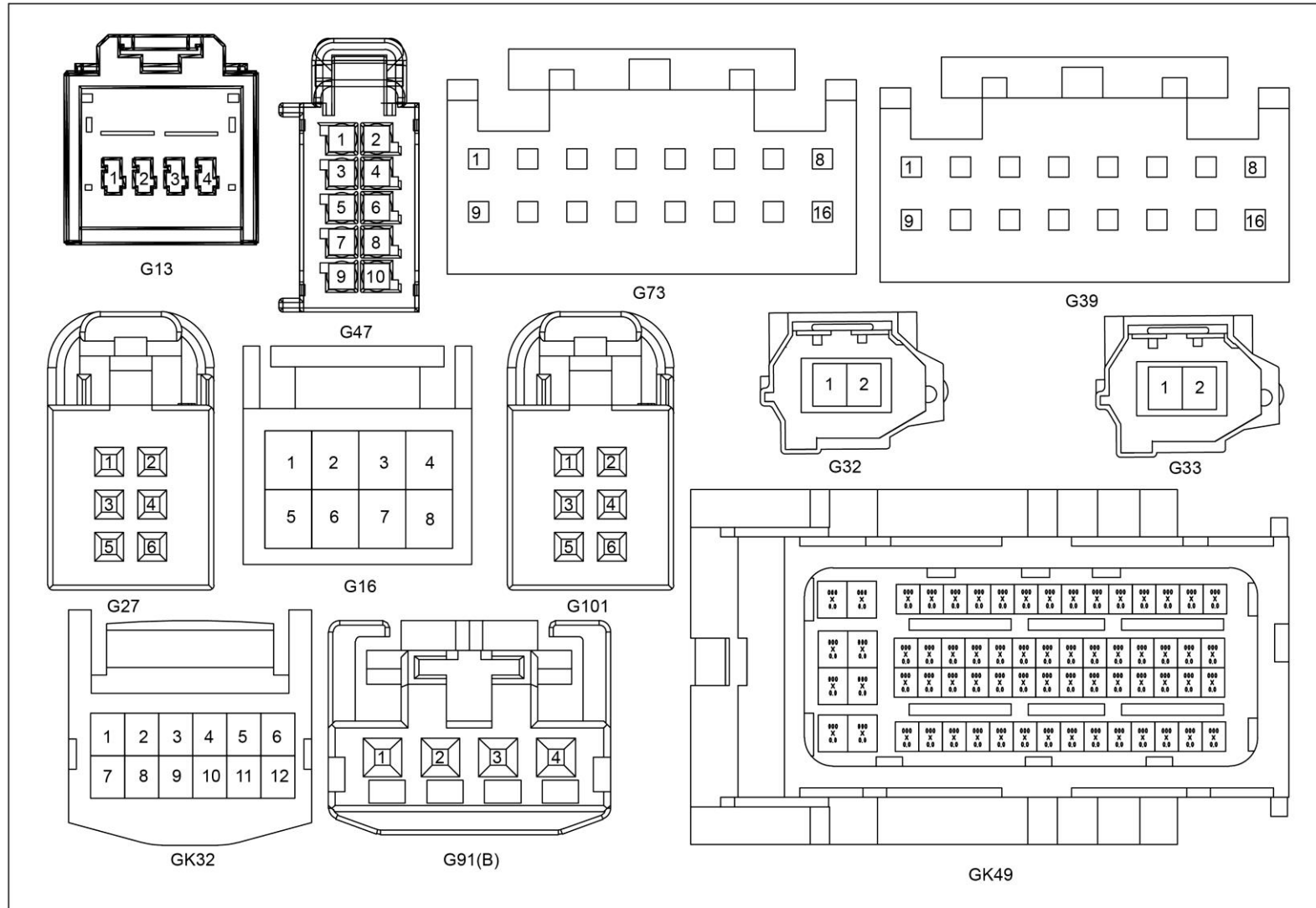

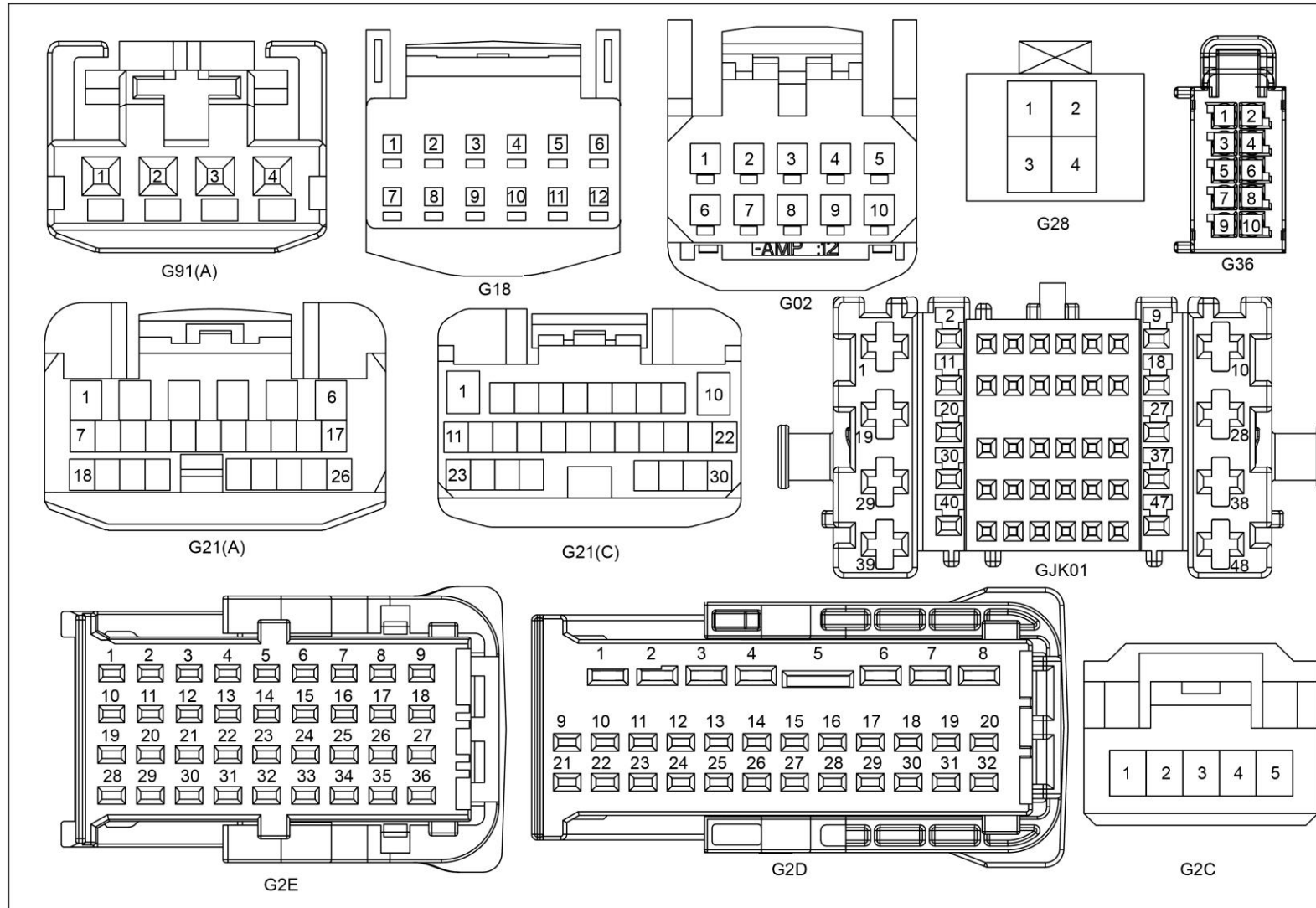

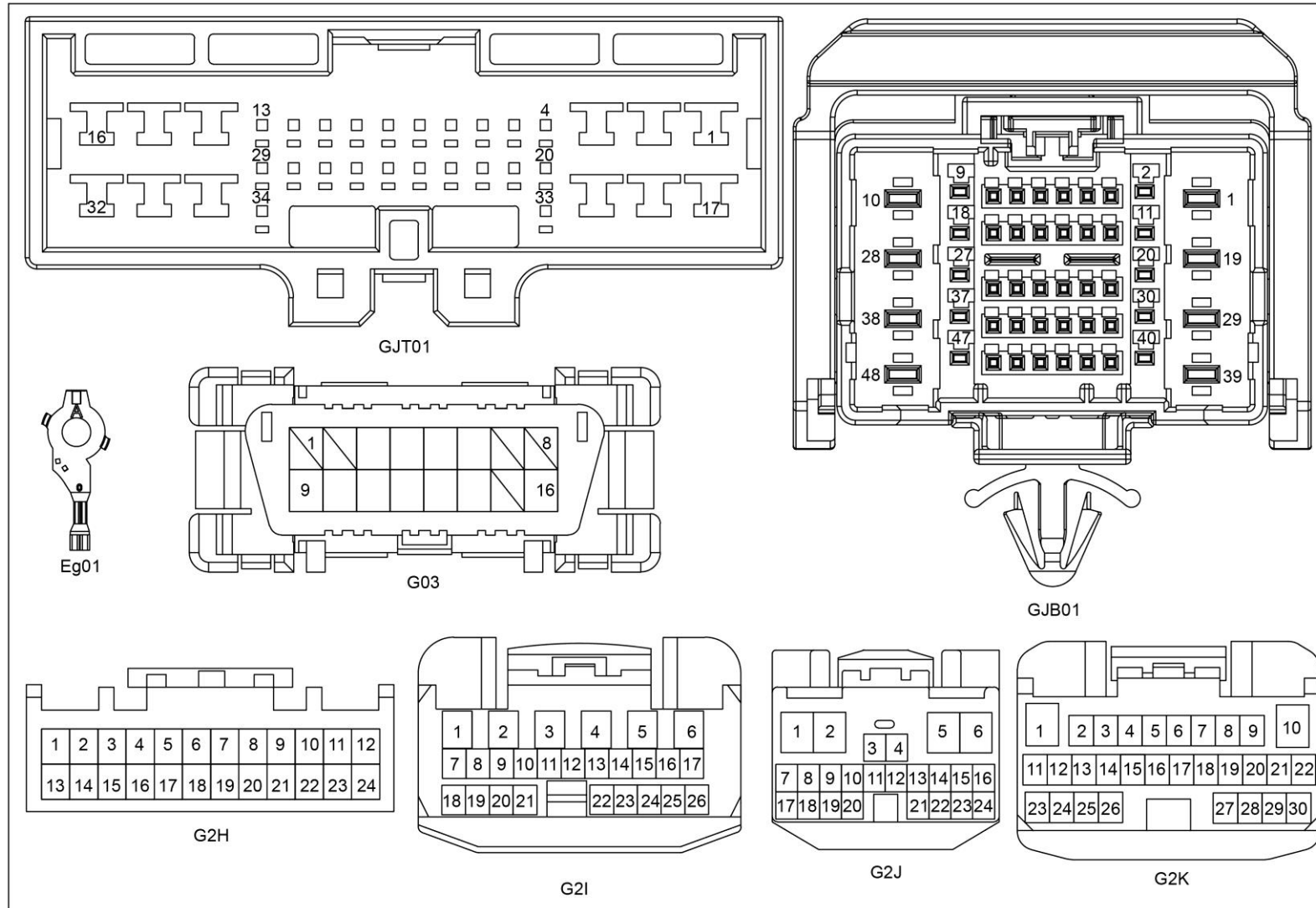



图					
序号 No.	零件编号 Part No.	名 称 Description		数量 Qty	备注 Rem
		中 文 Chinese	英 文 English		
01	G22	接空调小线			
02	G21(B)	接自动空调面板 控制器 B			
03	G07	接收音机			
04	G38(A)	接左脚部氛围灯			
05	Eg02	接 2#搭铁			
06	G05	接室内温度传感 器			
07	Eg08	接 8#搭铁			
08	GJGa01	接仪表线束 1			
09	Eg03	接 3#搭铁			
10	Eg04	接 4#搭铁			
11	G11	接 PAB			
12	G19	接网关控制器			
13	G24	接前鼓风机调速 模块			
14	G43	接备用电源			
15	G23	接鼓风机			
16	G43(A)	接收音机电源模 块			

电路图册

17	G38(B)	接副驾脚步氛围灯			
18	G41	接天线放大器电源			
19	G93	接 4G 模块			
20	Eg06	接 6#搭铁			
21	GJU01	接右前门线束 1			
22	GJK03	接地板线束			
23	GJB02	接仪表线束 2			
24	GJK02	接地板线束 2			
25	G88	接出租车小线接口 1			
26	G13	接 DAB			
27	G27	接 ESC OFF 开关			
28	G101	接音量旋钮			
29	G47	接中控台开关组			
30	G32	接前部磁卡探测天线总成			
31	G73	接模式开关			
32	G39	接档位传感器(自复位式)			
33	G16	接启动按钮			
34	GK32	接 EPB 开关			
35	G91(B)	接后排 USB			
36	G33	接中部磁卡探测天线总成			
37	GK49	接整车控制器			

电路图册

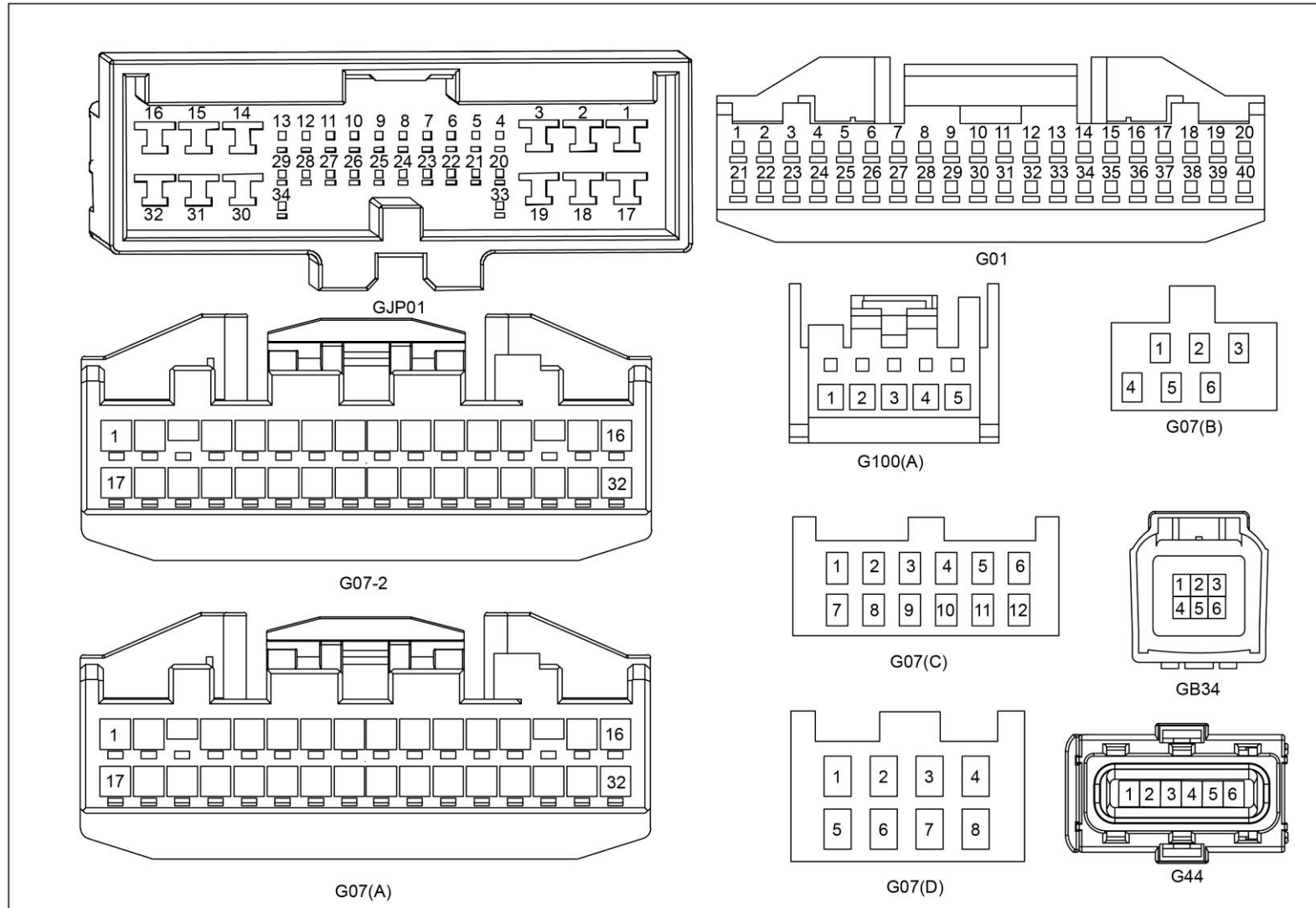
38	G91(A)	接前排 USB			
39	G18	接时钟弹簧			
40	G28	接制动灯开关			
41	G02	接组合开关			
42	G21(A)	接空调控制器 A 口			
43	G21(C)	接空调控制器 C 口			
44	G36	接灯光开关组			
45	G2E	接仪表配电箱 E 口			
46	G2C	接仪表配电箱 C 口			
47	G2D	接仪表配电箱 D 口			
48	GJK01	接地板线束 1			
49	GJT01	接左前门线束 1			
50	Eg01	接 1#搭铁			
51	GJB01	接前舱线束			
52	G03	接诊断口			
53	G2H	接 BCM H 口			
54	G2I	接 BCM I 口			
55	G2J	接 BCM J 口			
56	G2K	接 BCM K 口			
57	GJP01	接顶棚线束			
58	G07-2	接 8 寸屏			
59	G01	接组合仪表			

电路图册

60	G07(C)	接主机 M7			
61	G100(A)	接 PAD 旋转电机			
62	G07(A)	接主机 M1			
63	G07(B)	接主机 M5			
64	G07(D)	接主机 M6			
65	GB34	接 PTC 风加热器			
66	G44	接加速踏板传感器			

电路图册

9、仪表板线束 II

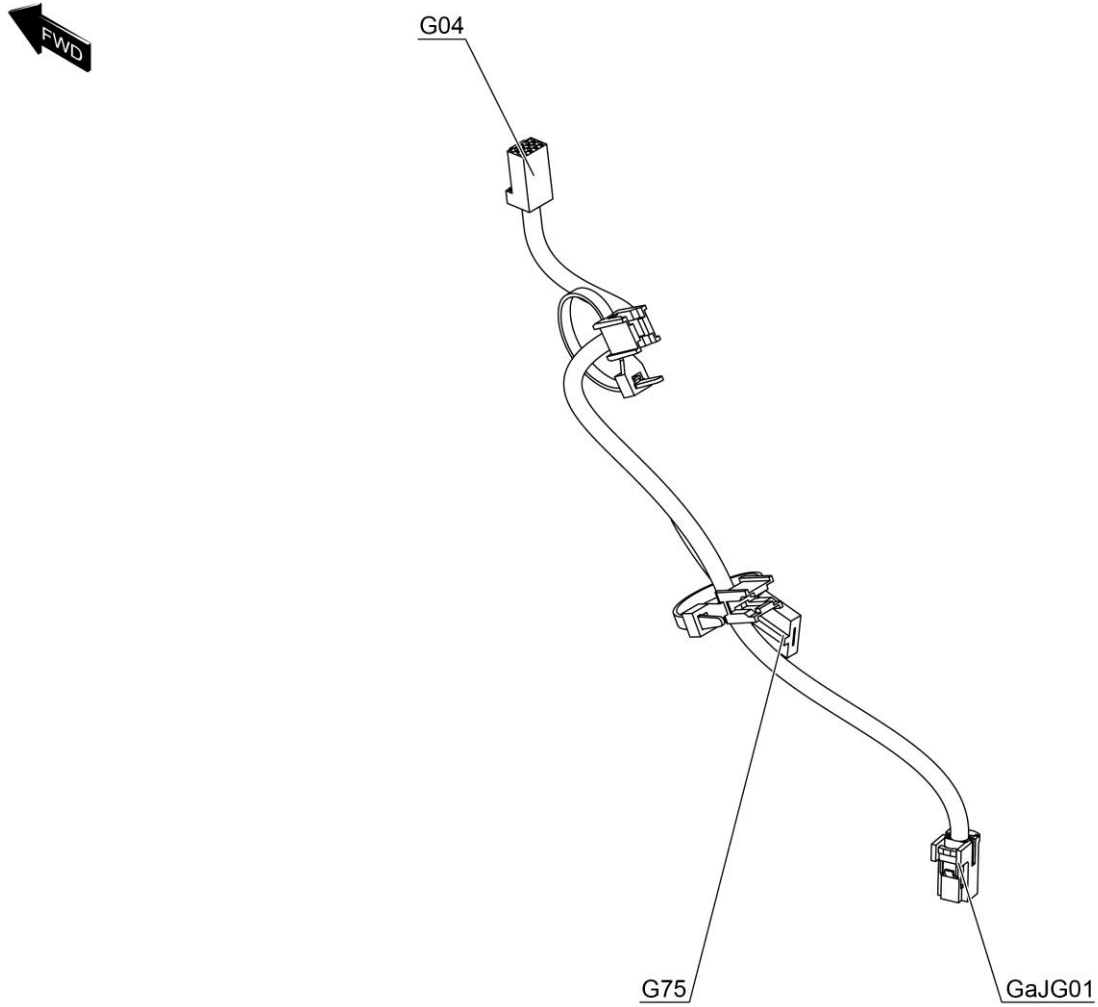



图					
序号 No.	零件编号 Part No.	名 称 Description		数量 Qty	备注 Rem
		中 文 Chinese	英 文 English		
01	G04	接二合一传感器			
02	GaJG01	接仪表线束			
03	G75	接吹面出风口温度传感器			

电路图册

10、地板线束



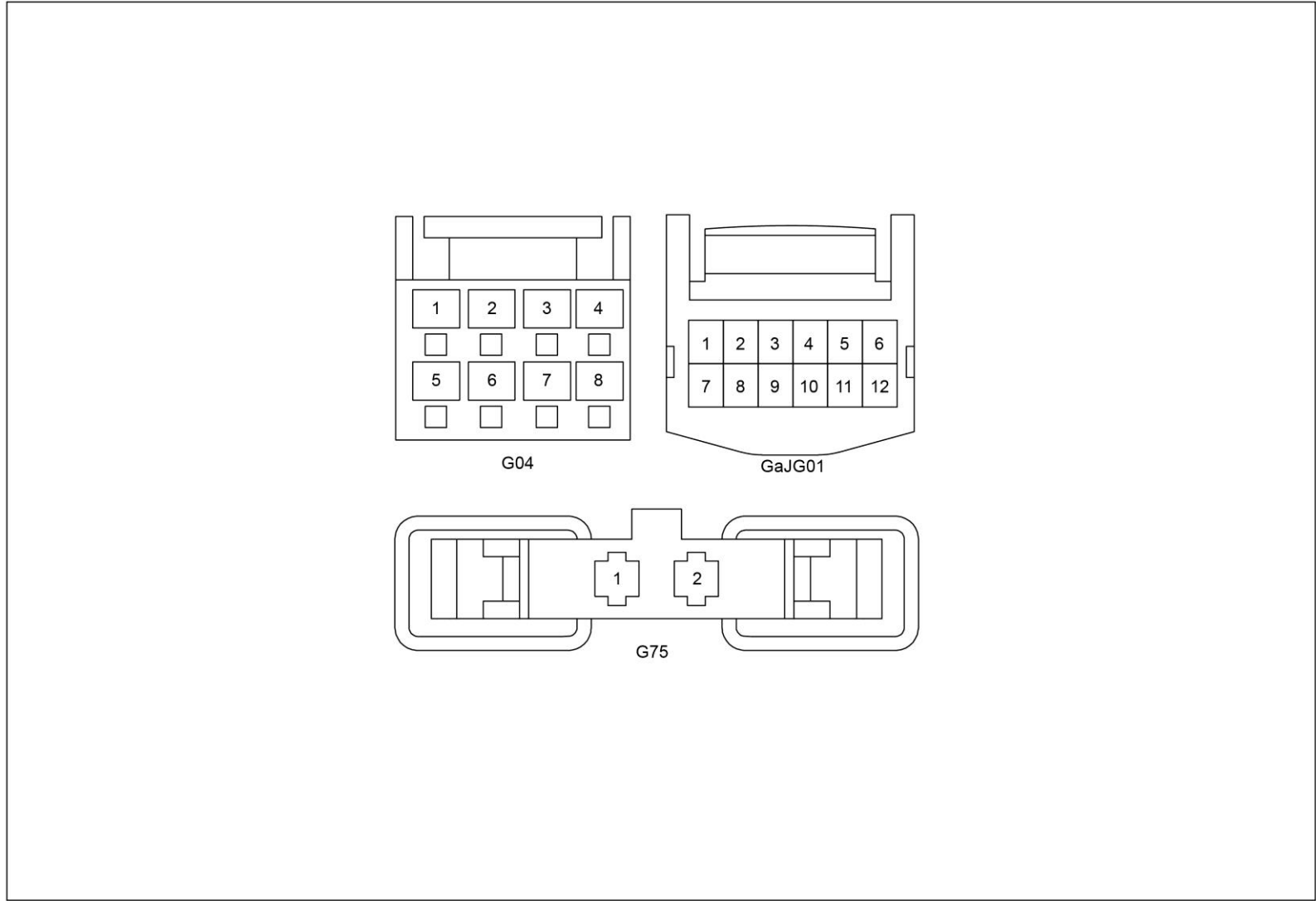
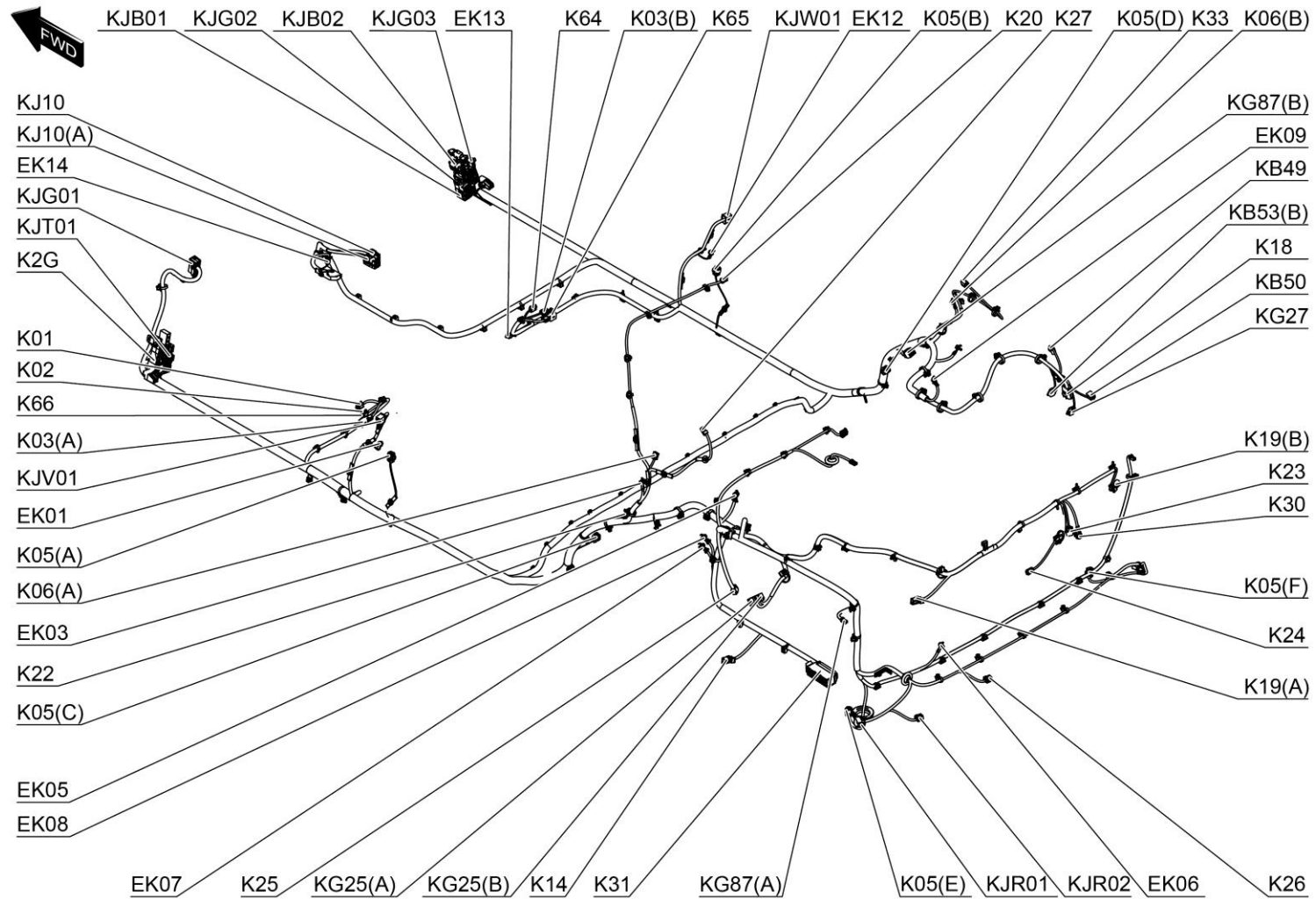
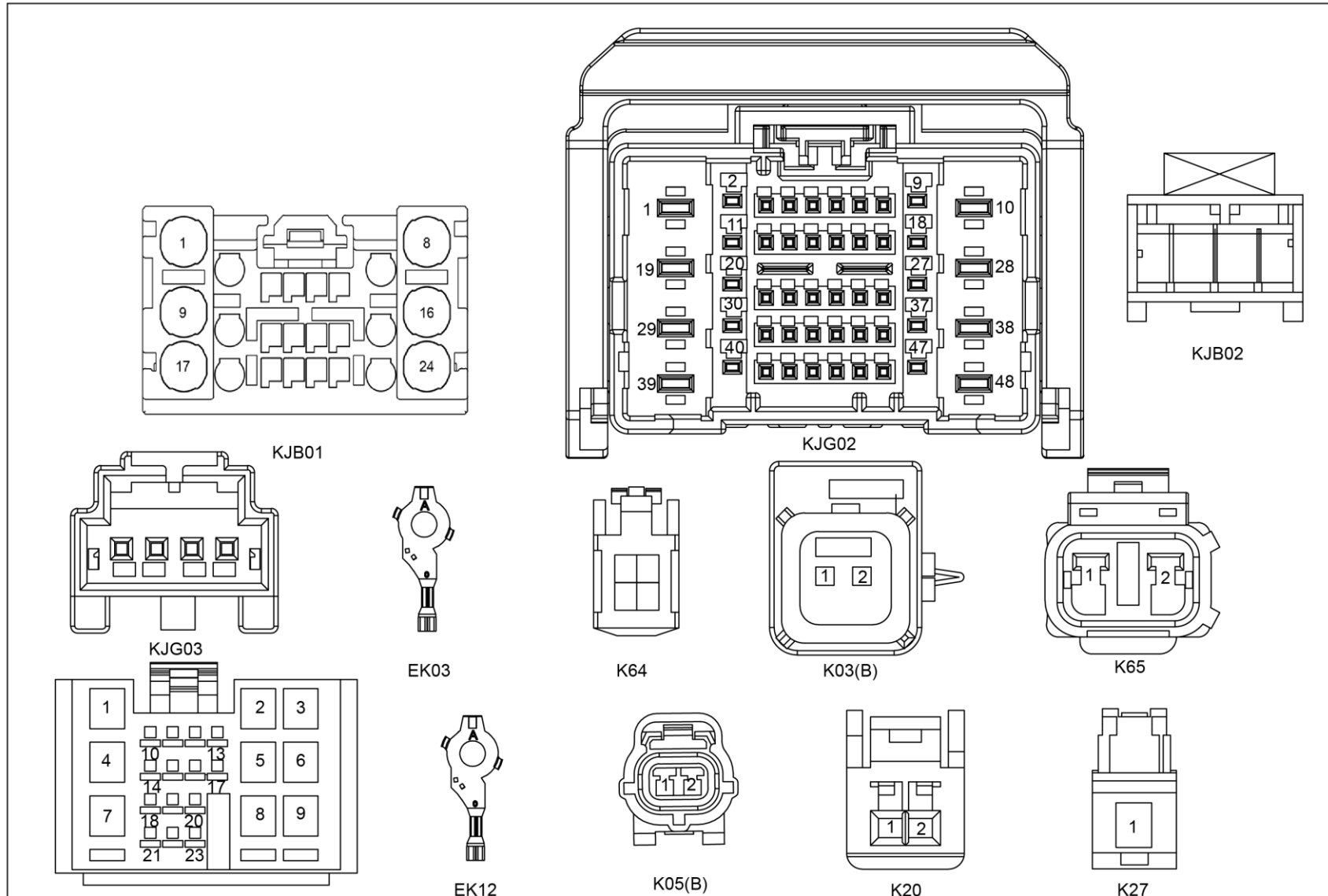

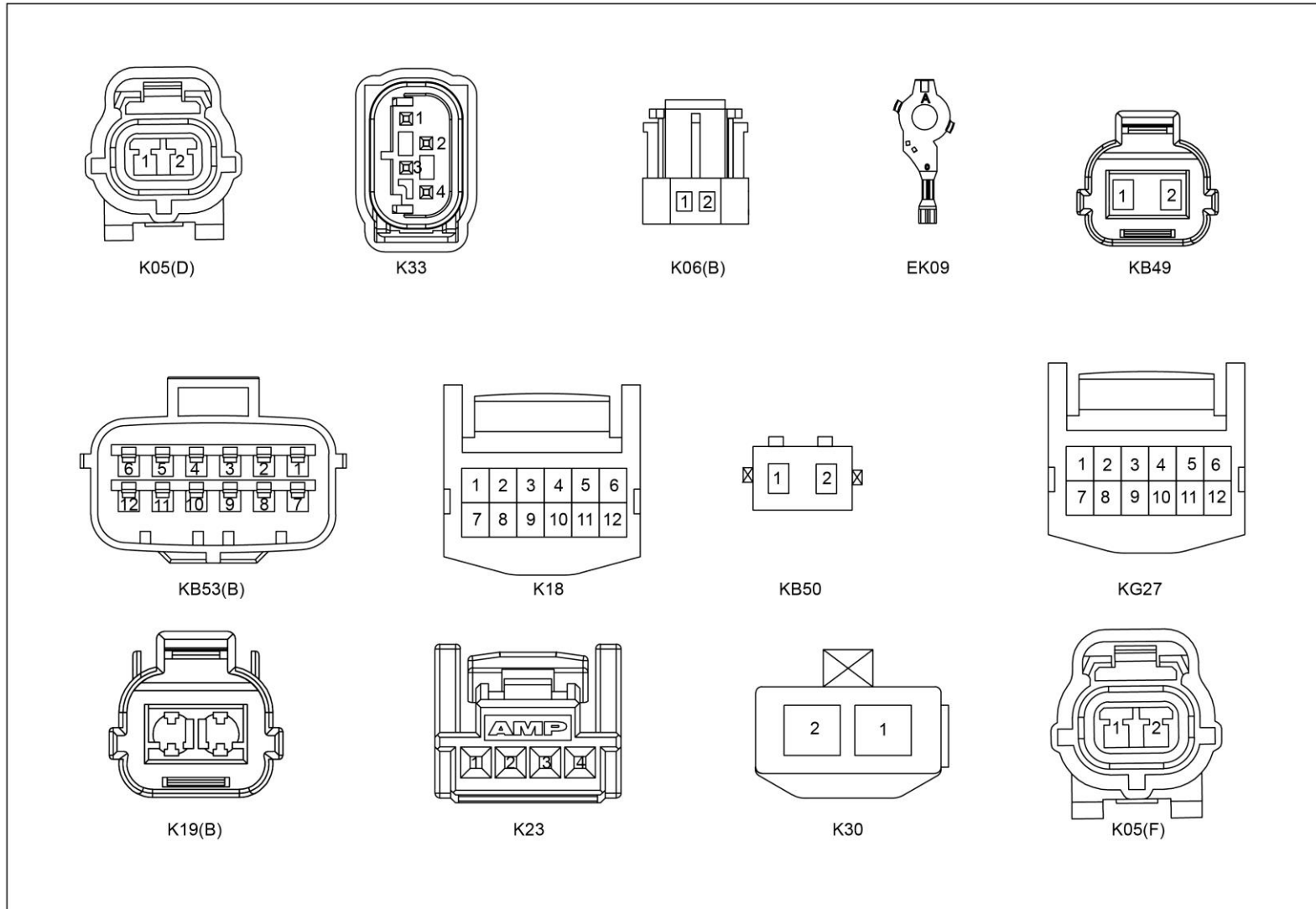

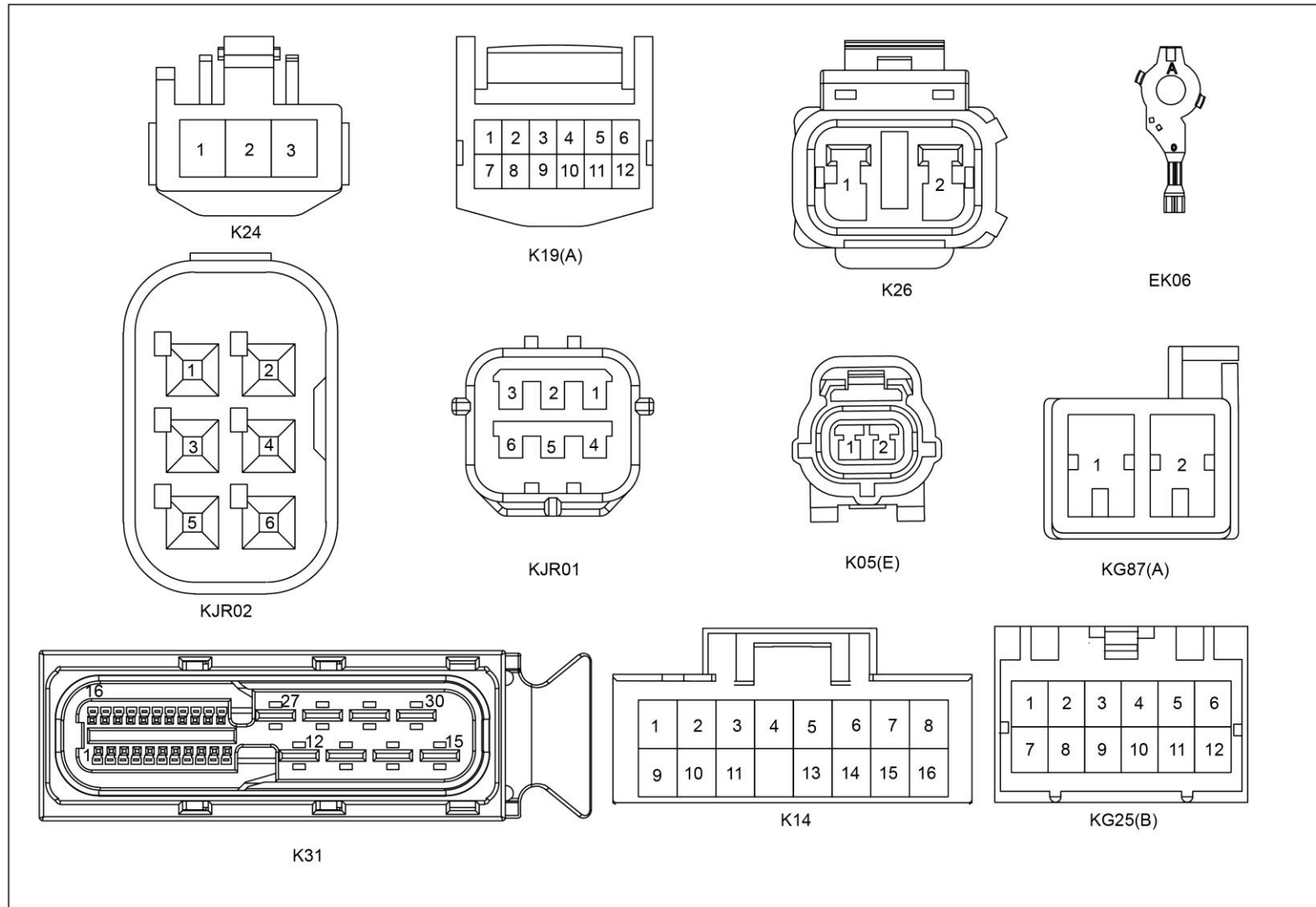

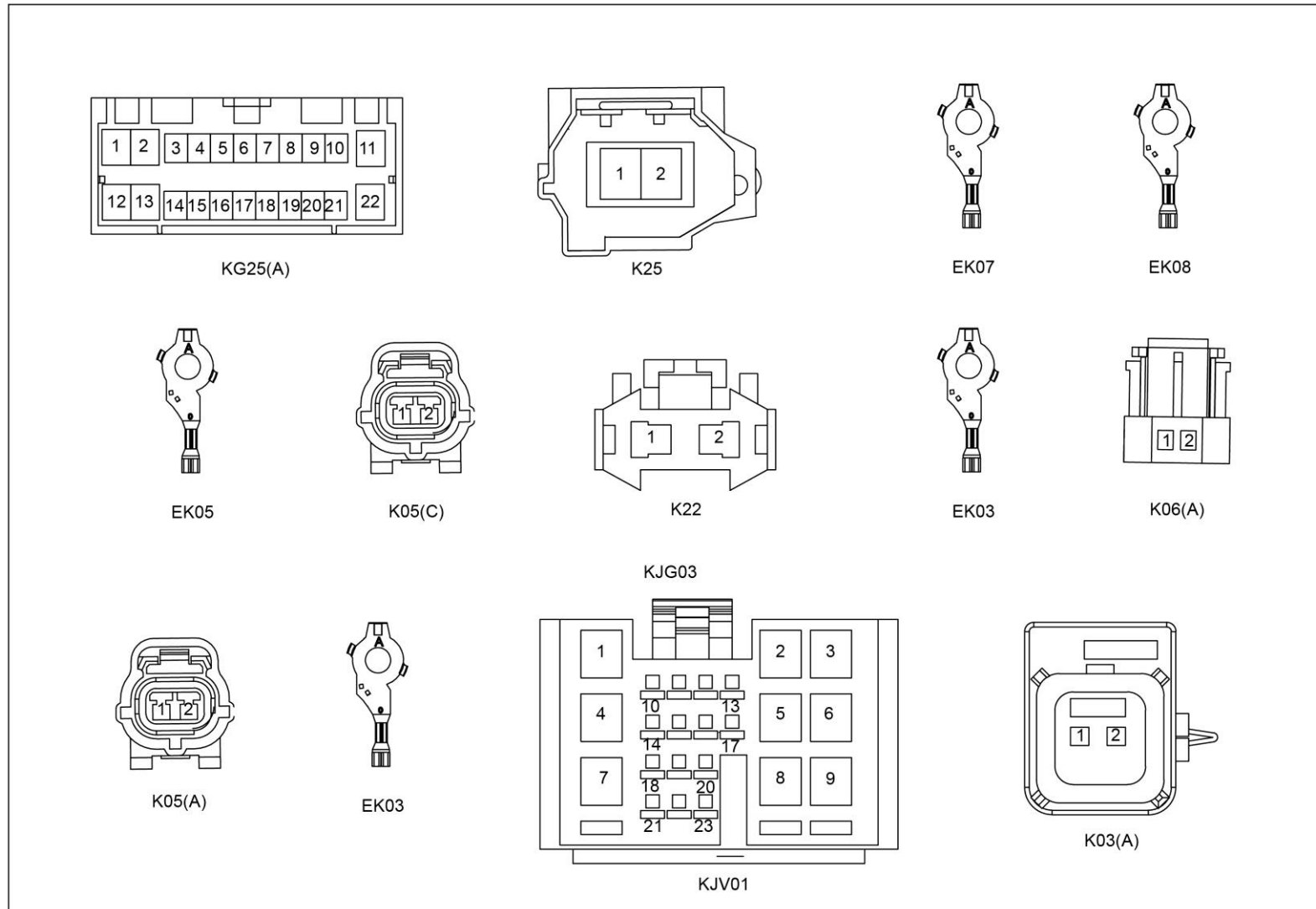



KG25(A)



图					
序号 No.	零件编号 Part No.	名 称 Description		数量 Qty	备注 Rem
		中 文 Chinese	英 文 English		
01	KJB01	接前舱线束			
02	KJG02	接仪表线束			
03	KJB02	接前舱线束 2			
04	KJG03	接仪表线束			
05	EK13	接 13#搭铁			
06	K64	接副驾安全带扣			
07	K03(B)	接右前座椅侧气囊			
08	K65	接副驾安全带报警传感器			
09	KJW01	接右后门线束			
10	EK12	搭铁			
11	K05(B)	接右侧碰撞传感器			
12	K20	接高位制动灯			
13	K27	接后除霜加热丝			
14	K05(D)	接右后侧碰撞传感器			
15	K33	接胎压模块			
16	K06(B)	接右侧安全气帘			

电路图册

17	KG87(B)	接 ESC 网终端电阻			
18	EK09	接 9#搭铁			
19	KB49	接交流充电口照明灯			
20	KB53(B)	接交流充电口			
21	K18	接右后组合灯			
22	KB50	接侧围充电口盖执行器			
23	KG27	接充电口盖微动开关			
24	K19(B)	接后尾灯			
25	K23	接后 LOGO 灯			
26	K30	接后背门微动开关			
27	K05(F)	接右后碰撞传感器			
28	K24	接行李箱锁电机			
29	K19(A)	接左尾灯			
30	K26	节后行李箱车外磁卡探测天线			
31	EK06	接 6#搭铁			
32	KJR02	接后保险杠线束 2			
33	KJR01	接后保险杠线束 1			
34	K05(E)	接左后碰撞传感器			
35	KG87(A)	接舒适网 1 终端			

电路图册

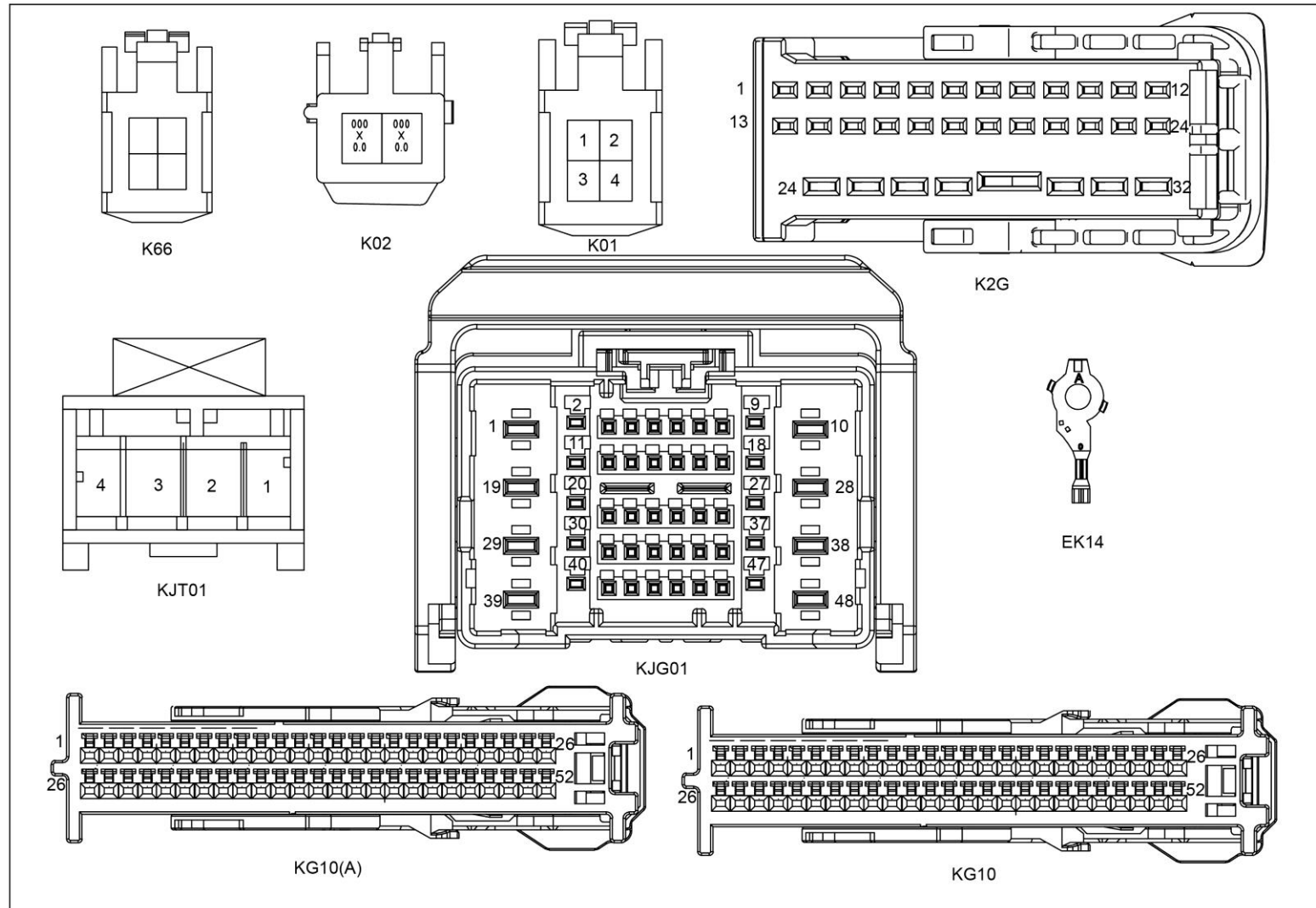
		电阻			
36	K31	接 EPC ECU			
37	K14	接驻车辅助模块 ECU			
38	KG25(B)	接智能钥匙系统控制器 B			
39	KG25(A)	接智能钥匙系统控制器 A			
40	K25	接后部磁卡探测天线总成			
41	EK07	接 7#搭铁			
42	EK08	接 8#搭铁			
43	EK05	接 5#搭铁			
44	K05(C)	接左后侧碰撞传感器			
45	K22	接行李箱灯			
46	EK03	接 3#搭铁			
47	K06(A)	接左侧安全气囊			
48	K05(A)	接左侧碰撞传感器			
49	EK01	接 1#搭铁			
50	KJV01	接左后门线束			
51	K03(A)	接左前座椅侧气囊			
52	K66	接主驾安全带扣			
53	K02	接座椅加热垫			
54	K01	接主驾座椅小线			
55	K2G	接 BCM G 口			

电路图册

56	KJT01	接左前门线束			
57	KJG01	接仪表线束			
58	EK14	接 14#搭铁			
59	KJ10(A)	接 SRS ECU(4, 6 气囊)			
60	KJ10	接 SRS ECU 2 气 囊			

电路图册

11、前舱线束

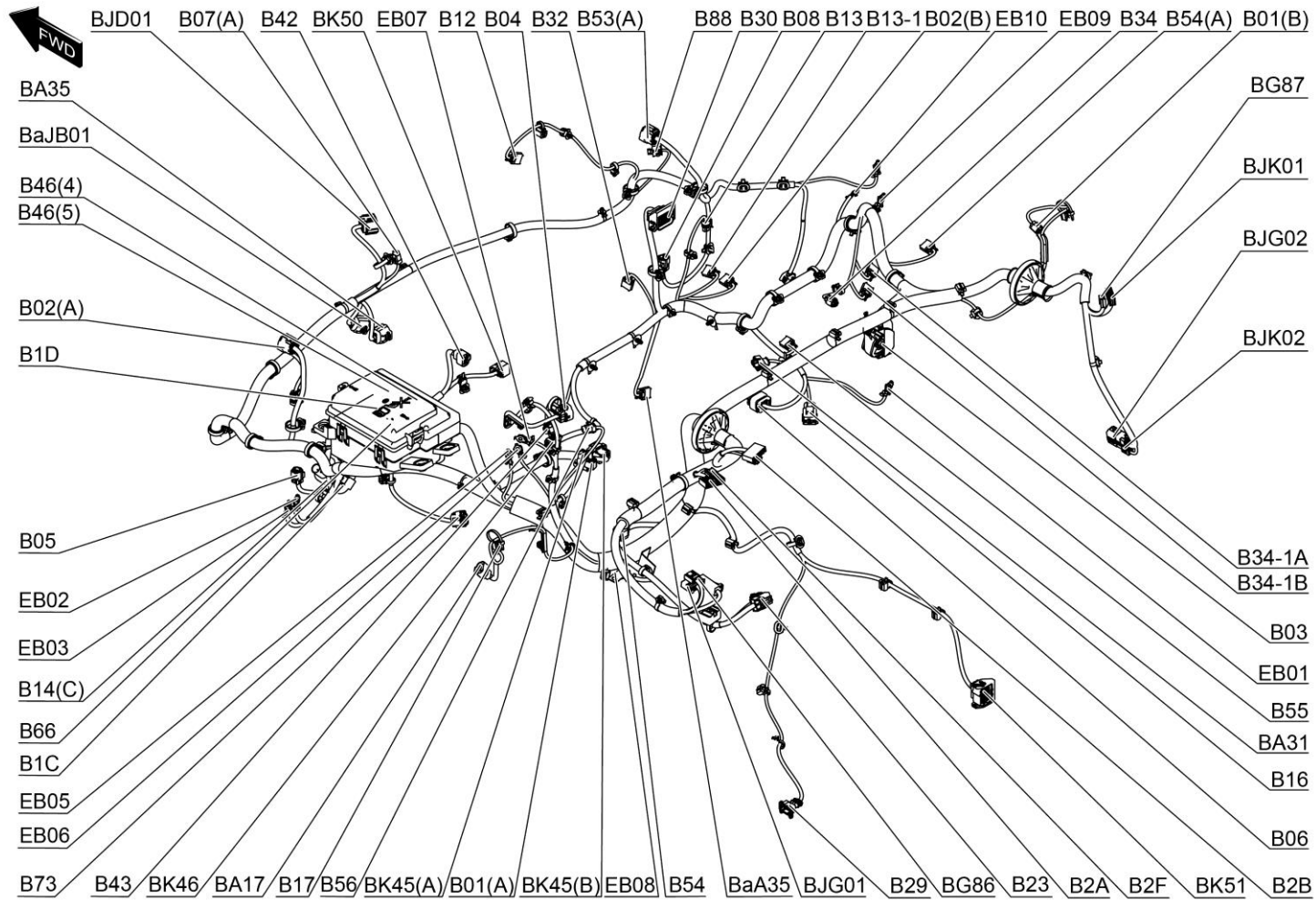

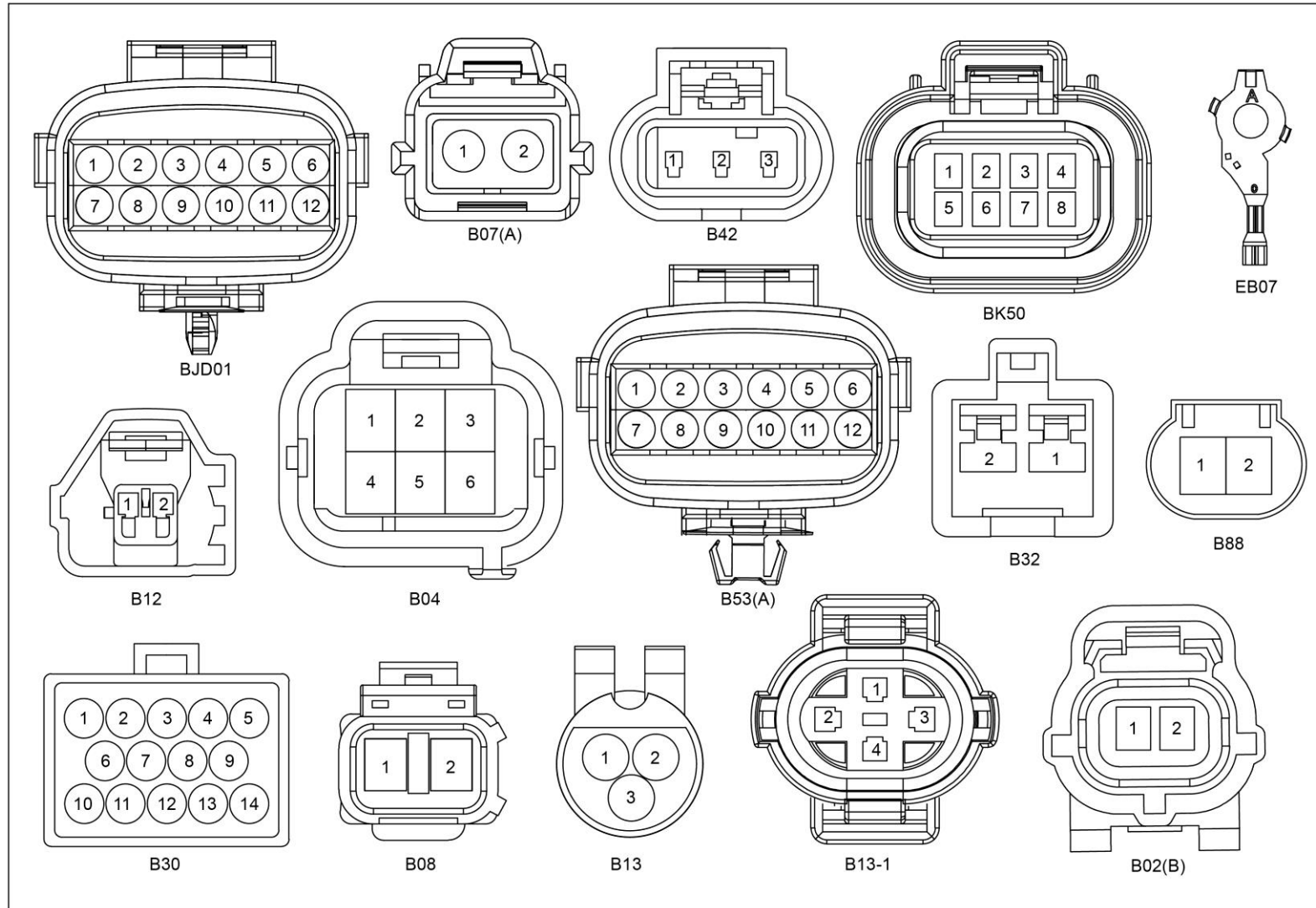

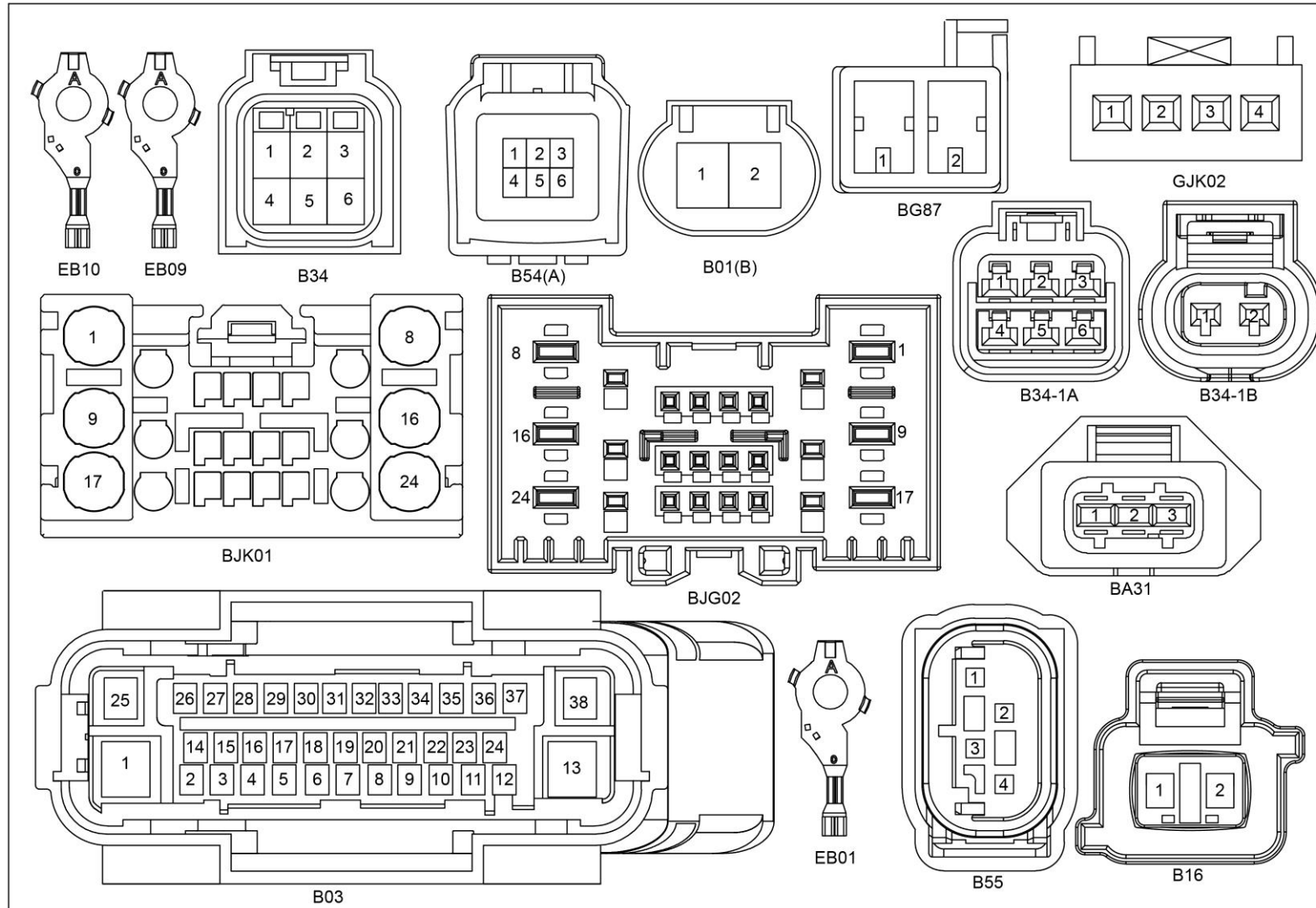

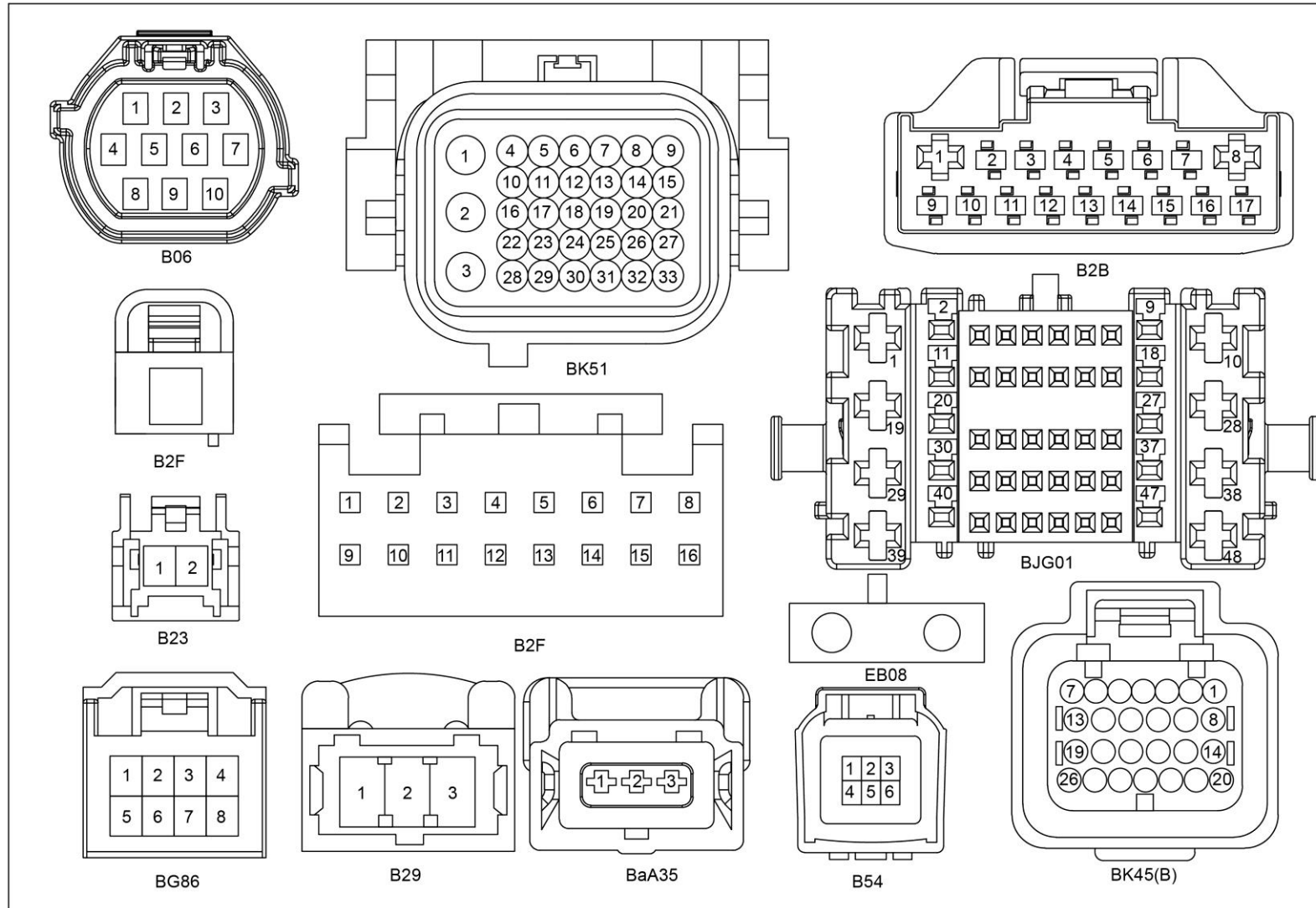

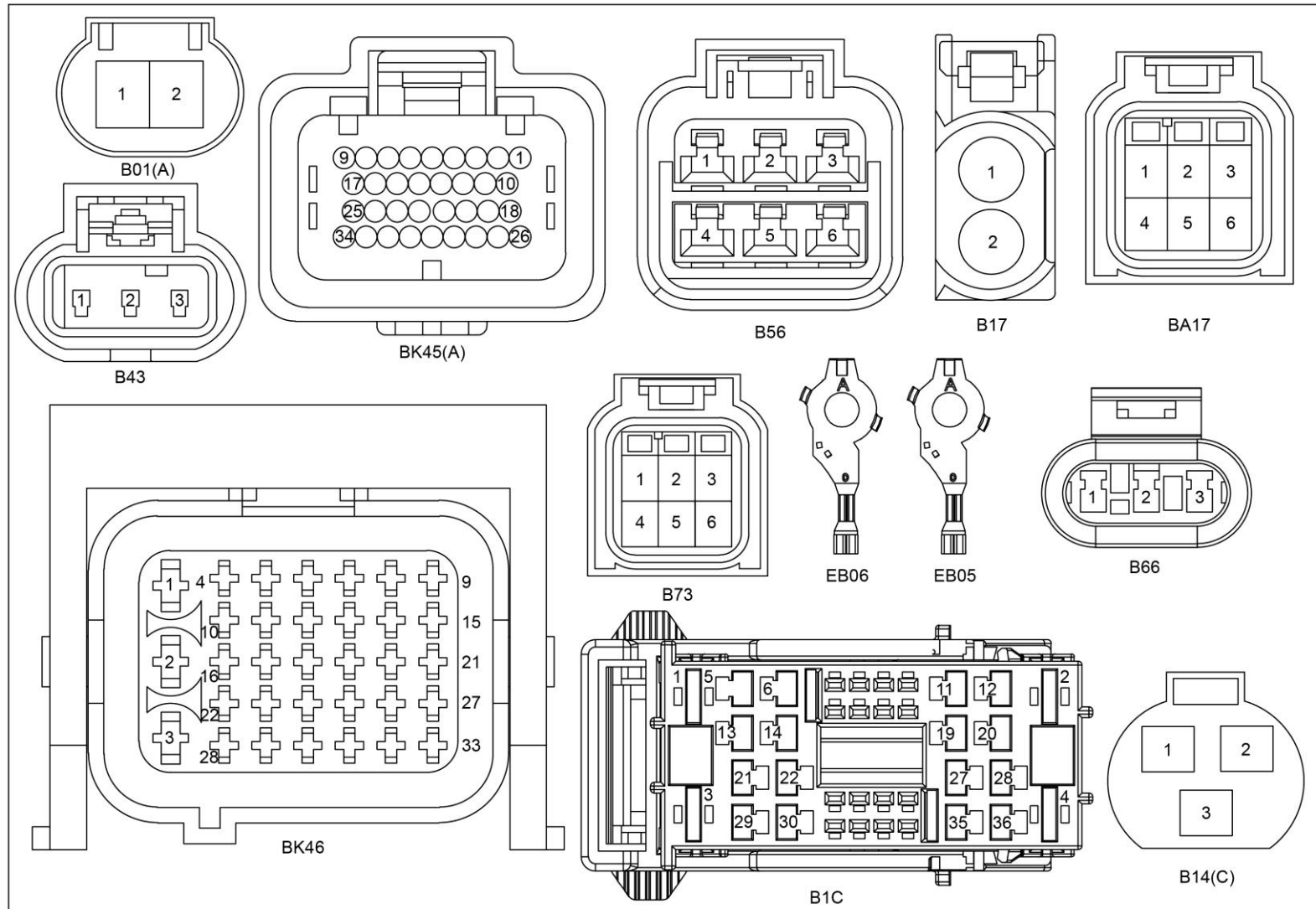



图					
序号 No.	零件编号 Part No.	名 称 Description		数量 Qty	备注 Rem
		中 文 Chinese	英 文 English		
01	BJD01	接前保小线			
02	B07(A)	接高音喇叭			
03	B42	接暖风水泵			
04	BK50	接蓄电池 BMS			
05	EB07	接 7#搭铁			
06	B12	接室外温度传感器			
07	B04	接雨刮电机			
08	B32	接真空泵			
09	B53(A)	接直流充电口			
10	B88	接引擎模拟器			
11	B30	接驱动电机控制器			
12	B08	接前舱盖锁内微动开关			
13	B13	接压力传感器			
14	B13-1	接空调压力开关			
15	B02(B)	接右前碰传感器			
16	EB10	接 10#搭铁			
17	EB09	接 9#搭铁			
18	B34	接 PTC 水加热器			

电路图册

19	B54(A)	接电磁阀			
20	B01(B)	接右前轮速传感器			
21	BG87	接舒适网 2 终端电阻			
22	BJK01	接前舱对地板线束 1			
23	BJG02	接前舱对接仪表线束 2			
24	BJK02	接前舱对地板线束 2			
25	B34-1A	接燃油加热器 A			
26	B34-1B	接燃油加热器 B			
27	B03	接 ESP ECU			
28	EB01	接 1#搭铁			
29	B55	接 P+T 传感器			
30	BA31	接真空度传感器			
31	B16	接前洗涤电机			
32	B06	接右组合前灯			
33	BK51	接电池包			
34	B2B	接 BCM-B 端口			
35	B2F	接仪表板配电盒 F 口			
36	B2A	接 BCMA 口			
37	B23	接 REPS 电机			
38	BG86	接 CEPS ECU			
39	B29	接水温传感器			
40	BJG01	接仪表线束 1			

电路图册

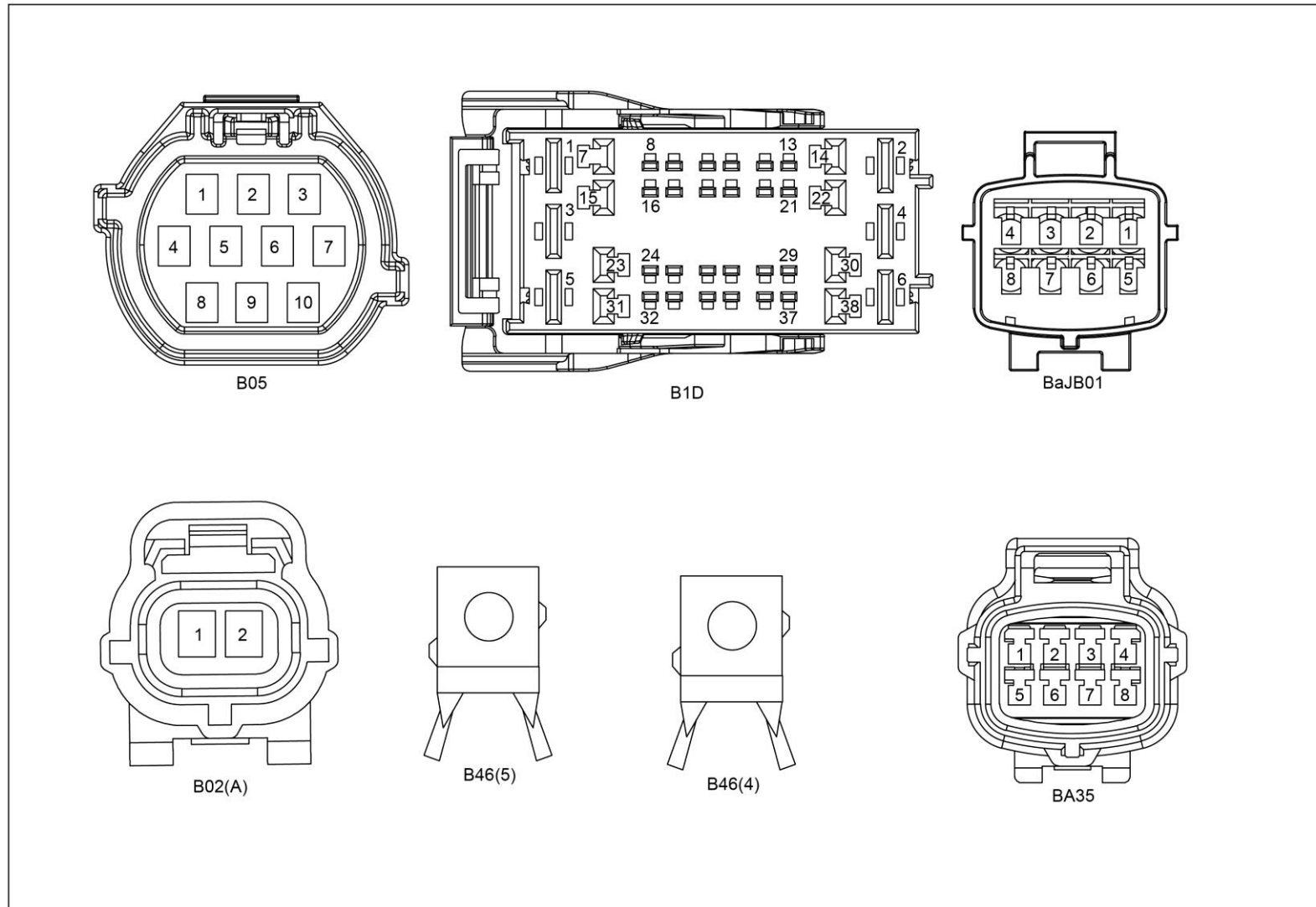
41	BaA35	接车速传感器			
42	B54	接电子膨胀阀			
43	EB08	接 C-EPS			
44	BK45(B)	接电池管理器 B 口			
45	B01(A)	接左前轮速传感器			
46	BK45(A)	接电池管理器 A 口			
47	B56	接四通阀			
48	B17	接制动液位开关			
49	BA17	接电动压缩机总成			
50	BK46	接充配电总成			
51	B43	接电机冷却水泵			
52	B73	接电池包加热器			
53	EB06	接 6#搭铁			
54	EB05	接 5#搭铁			
55	B1C	接前舱配电箱 C 口			
56	B66	接热管理水泵			
57	B14(C)	接两档风扇(单 风扇)			
58	EB03	接 3#搭铁			
59	EB02	接 2#搭铁			
60	B05	接左组合前灯总成			
61	B1D	接前舱配电箱 D 口			
62	B02(A)	接左前碰传感器			

电路图册

63	B46(5)	接前舱配电箱 5# 口(C-EPS)			
64	B46(4)	接前舱配电箱 4# 口(仪表配电)			
65	BaJB01	接前舱预留小线 3			
66	BA35	接出租车小线预 留 3			

12、蓄电池负极搭铁线束

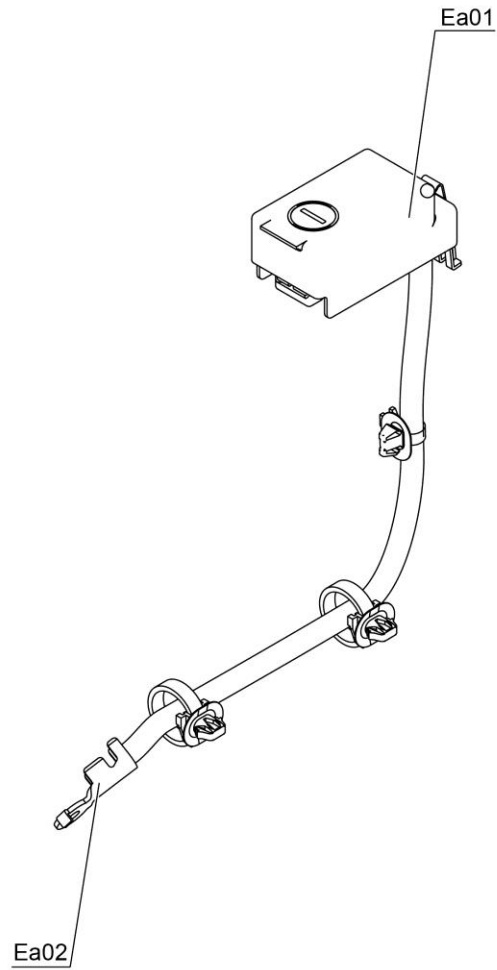

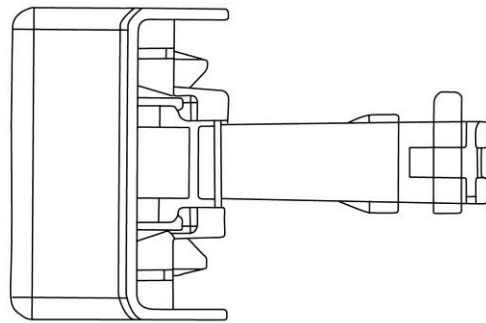

Ea01

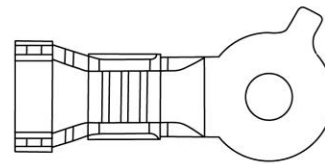

Ea02

图					
序号 No.	零件编号 Part No.	名 称 Description		数量 Qty	备注 Rem
		中 文 Chinese	英 文 English		
01	Ea01	接蓄电池负极搭铁			
02	Ea02	接车身搭铁			

13、主电机控制器外壳搭铁

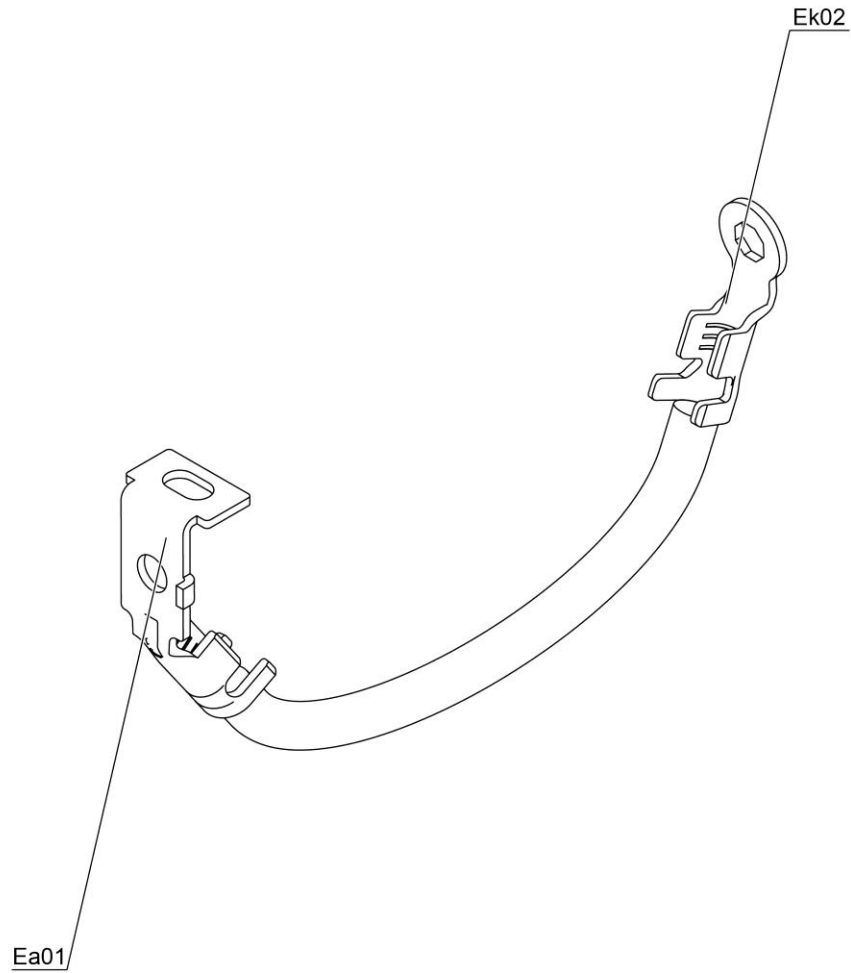



图					
序号 No.	零件编号 Part No.	名 称 Description		数量 Qty	备注 Rem
		中 文 Chinese	英 文 English		
01	Ek02	接车身搭铁			
02	Ea01	接主电机控制器 外壳搭铁			

14、高压配电箱搭铁线束



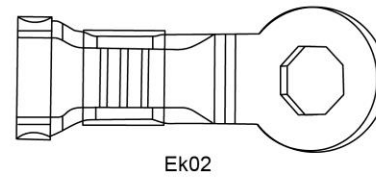
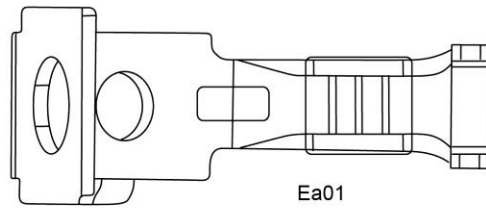
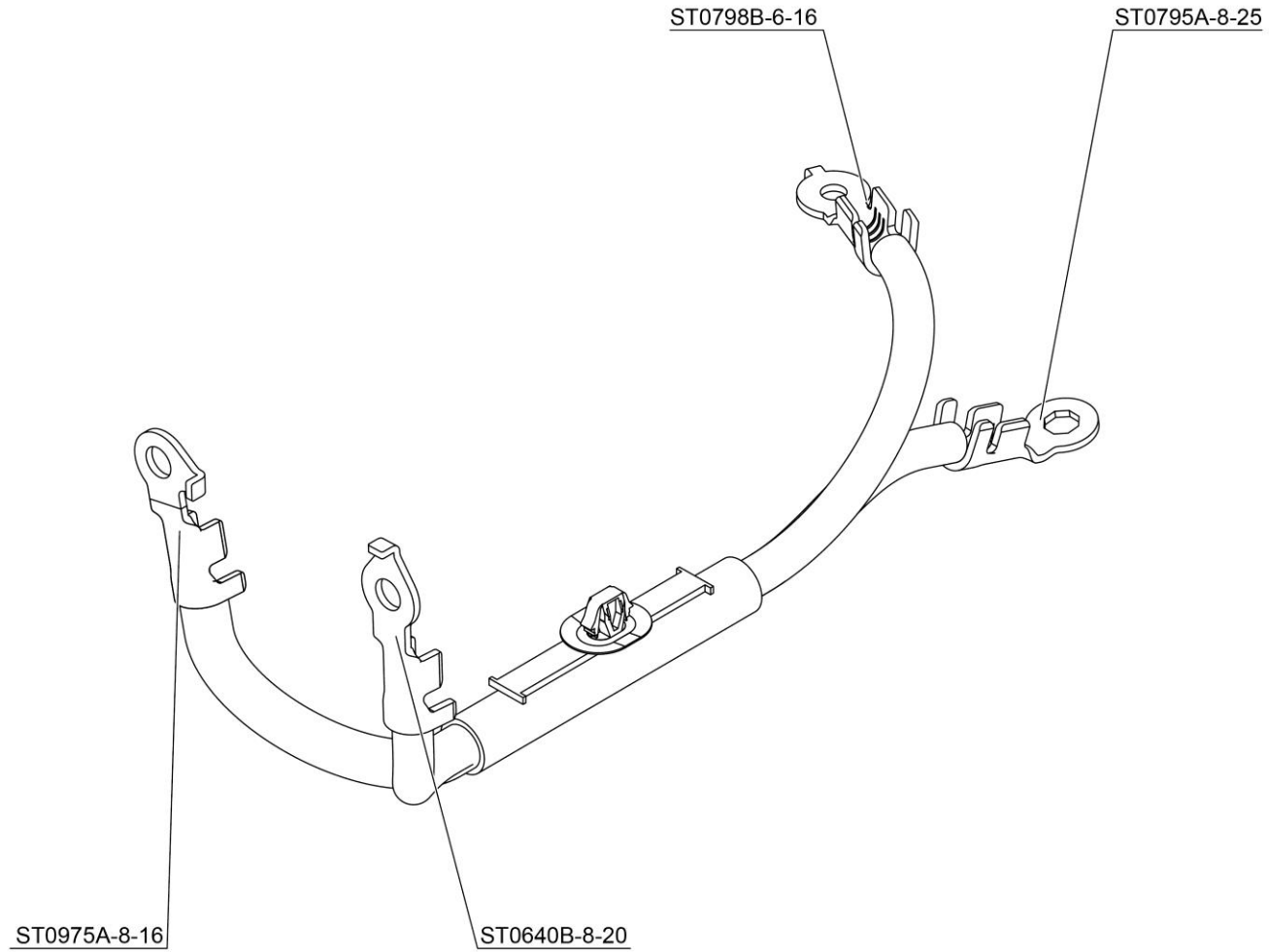
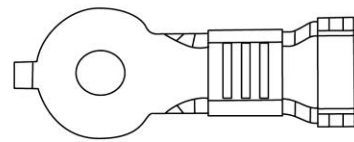

ST0798B-6-16

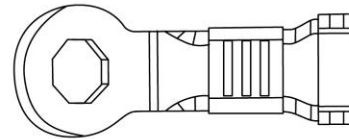

ST0795A-8-25

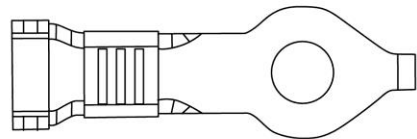

ST0640B-8-20

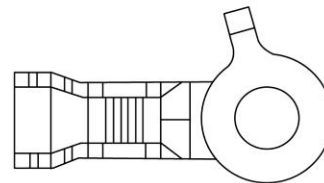

ST0975A-8-16

图					
序号 No.	零件编号 Part No.	名 称 Description		数 量 Qty	备注 Rem
		中 文 Chinese	英 文 English		
01	ST0798B-6 -16				无名称
02	ST0795A-8 -25				无名称
03	ST0640B-8 -20				无名称
04	ST0975A-8 -16				无名称

15、PTC 搭铁线束

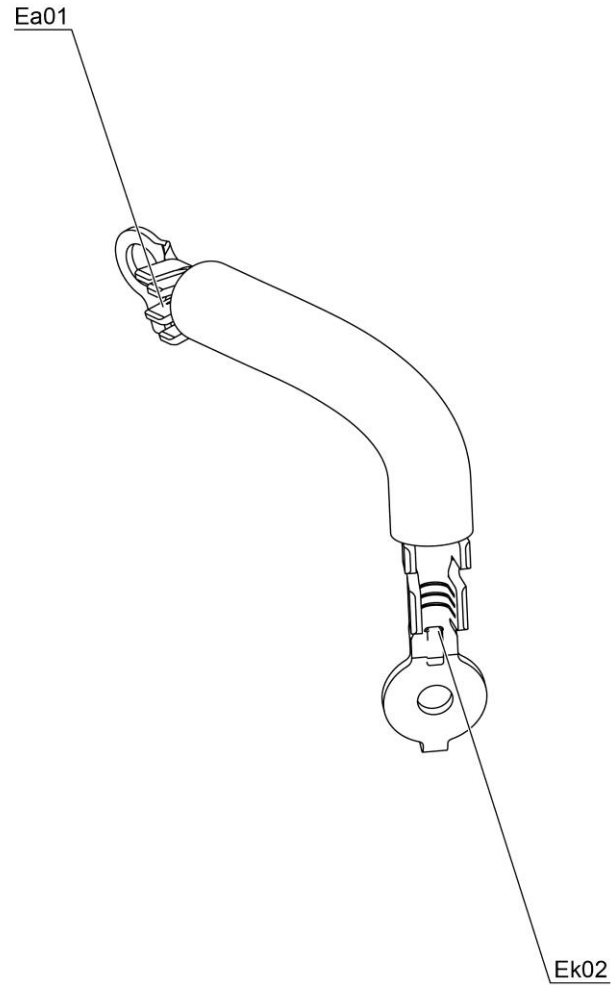

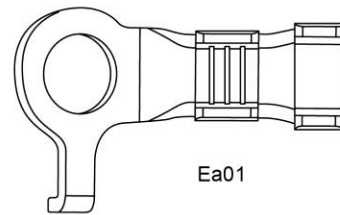

Ea01

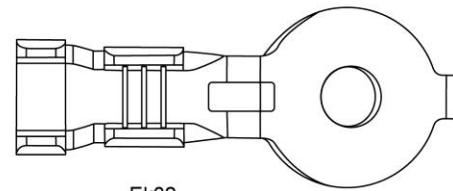

Ek02

图					
序号 No.	零件编号 Part No.	名 称 Description		数量 Qty	备注 Rem
		中 文 Chinese	英 文 English		
01	Ea01	接主电机控制器 外壳搭铁			
02	Ek02	接车身搭铁			

16、电池加热器外壳搭铁线束

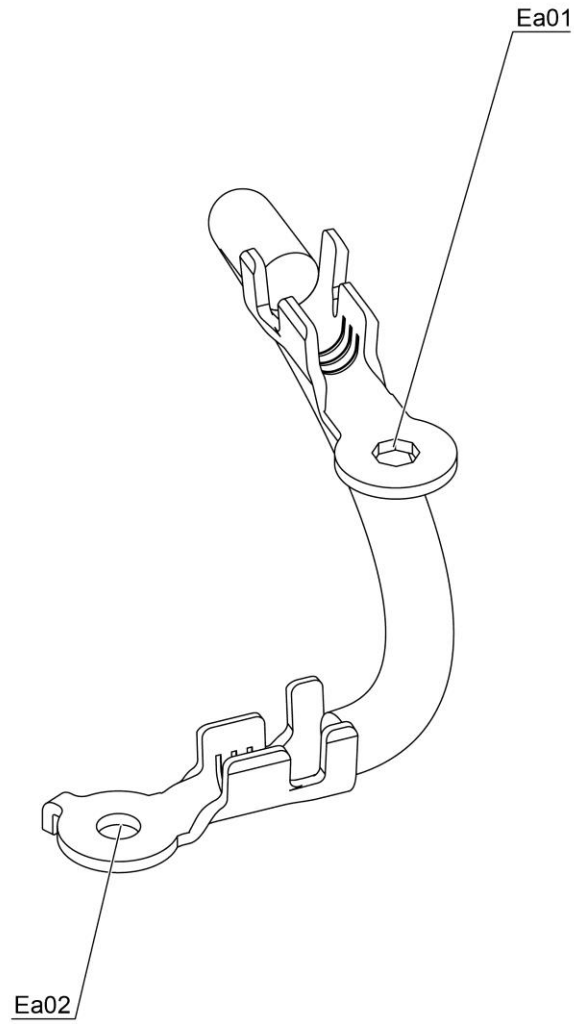

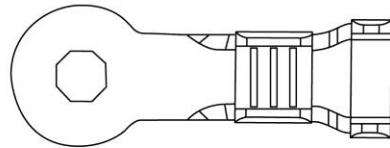

Ea01

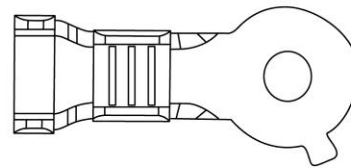

Ea02

图					
序号 No.	零件编号 Part No.	名 称 Description		数量 Qty	备注 Rem
		中 文 Chinese	英 文 English		
01	Ea01	接电池加热器外 壳			
02	Ea02	接车身搭铁			

17、前电机总成搭铁线束

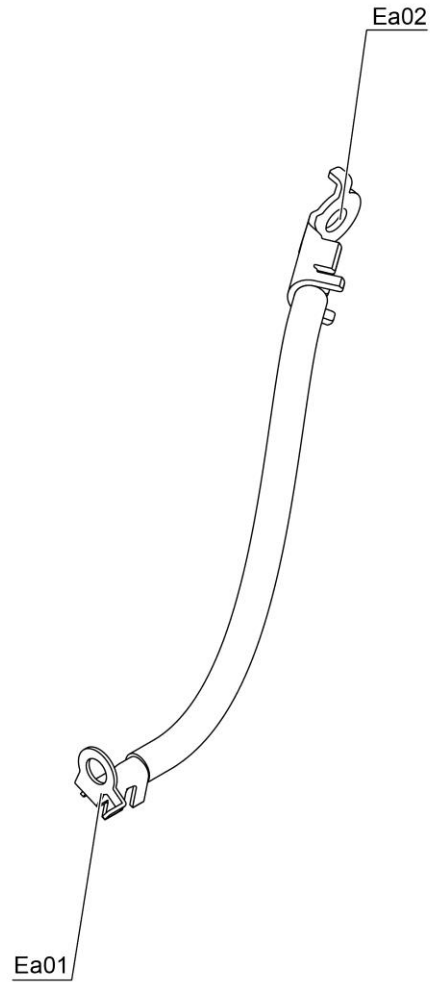

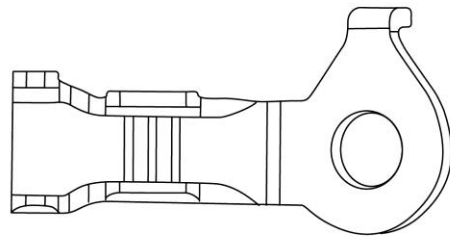

Ea02

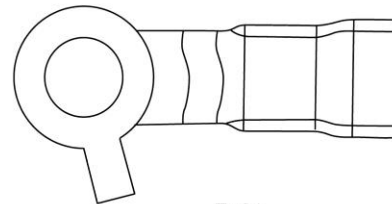

Ea01

图					
序号 No.	零件编号 Part No.	名 称 Description		数量 Qty	备注 Rem
		中 文 Chinese	英 文 English		
01	Ea02	接车身搭铁			
02	Ea01	接前电机总成搭铁			

电路图册

18、后风挡加热负极线

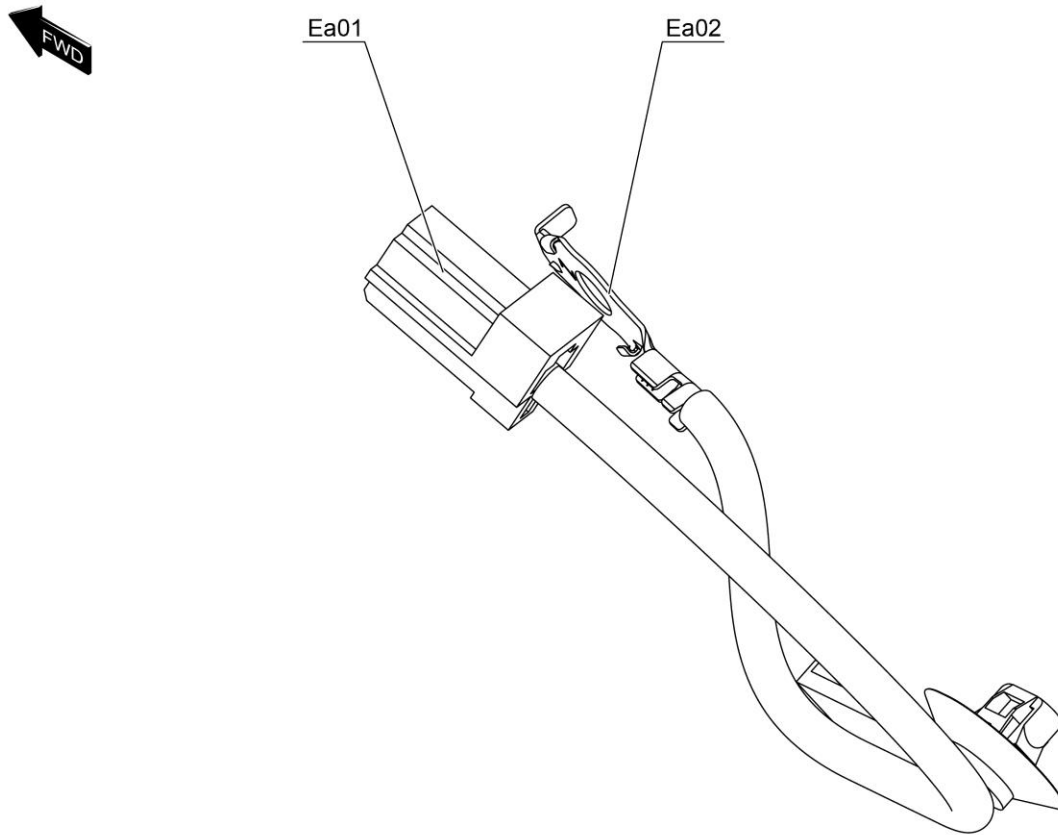

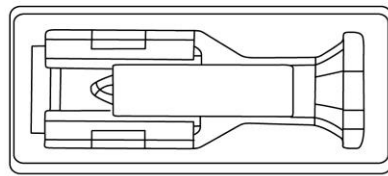

Ea01

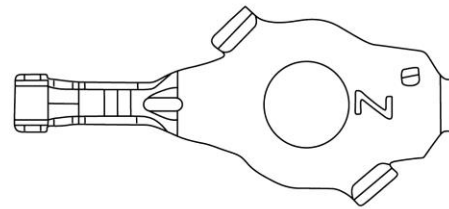

Ea02

图					
序号 No.	零件编号 Part No.	名 称 Description		数量 Qty	备注 Rem
		中 文 Chinese	英 文 English		
01	Ea01	接后风挡搭铁			
02	Ea02	接车身搭铁			

电路图册

19、电池包搭铁线束

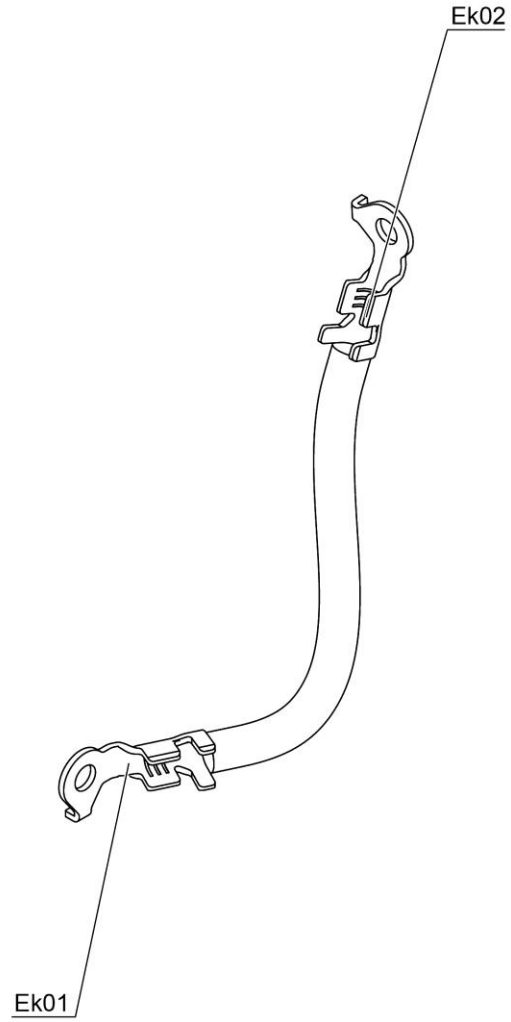



图					
序号 No.	零件编号 Part No.	名 称 Description		数量 Qty	备注 Rem
		中 文 Chinese	英 文 English		
01	Ek02	接车身搭铁			
02	Ek01	接电池包搭铁			

电路图册

20、前保险杠小线



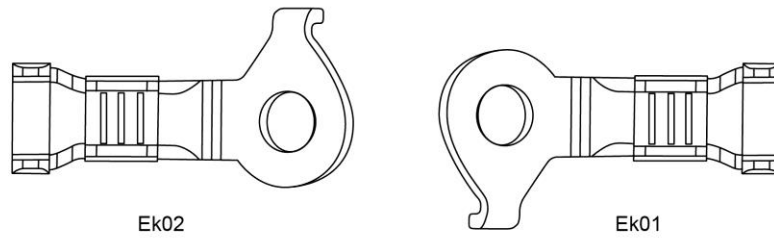
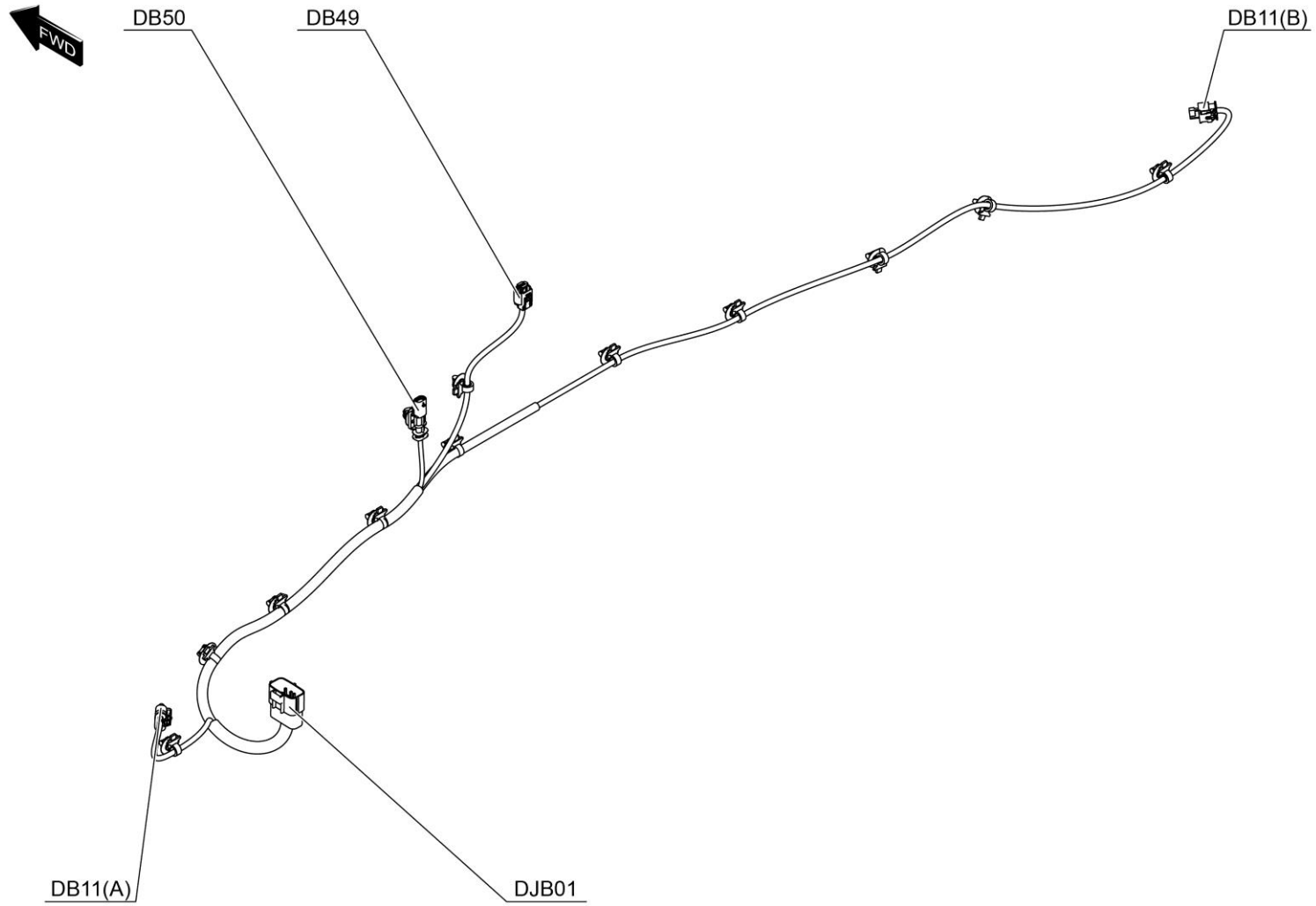
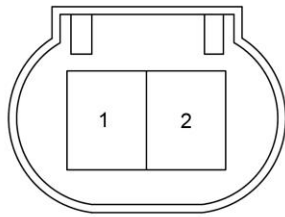

DB50

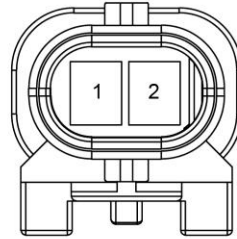

DB49

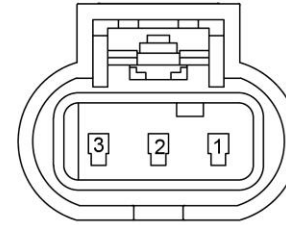

DB11(B)

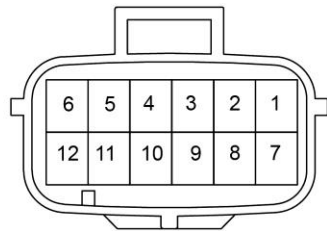

DJB01

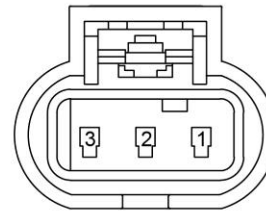

DB11(A)

图					
序号 No.	零件编号 Part No.	名 称 Description		数量 Qty	备注 Rem
		中 文 Chinese	英 文 English		
01	DB50	接前格栅充电口 盖执行器			
02	DB49	接直流充电口照 明灯			
03	DB11(B)	接右前间隙传感 器			
04	DJB01	接前舱线束			
05	DB11(A)	接左前间隙传感 器			

电路图册

21、2D 天线馈小线

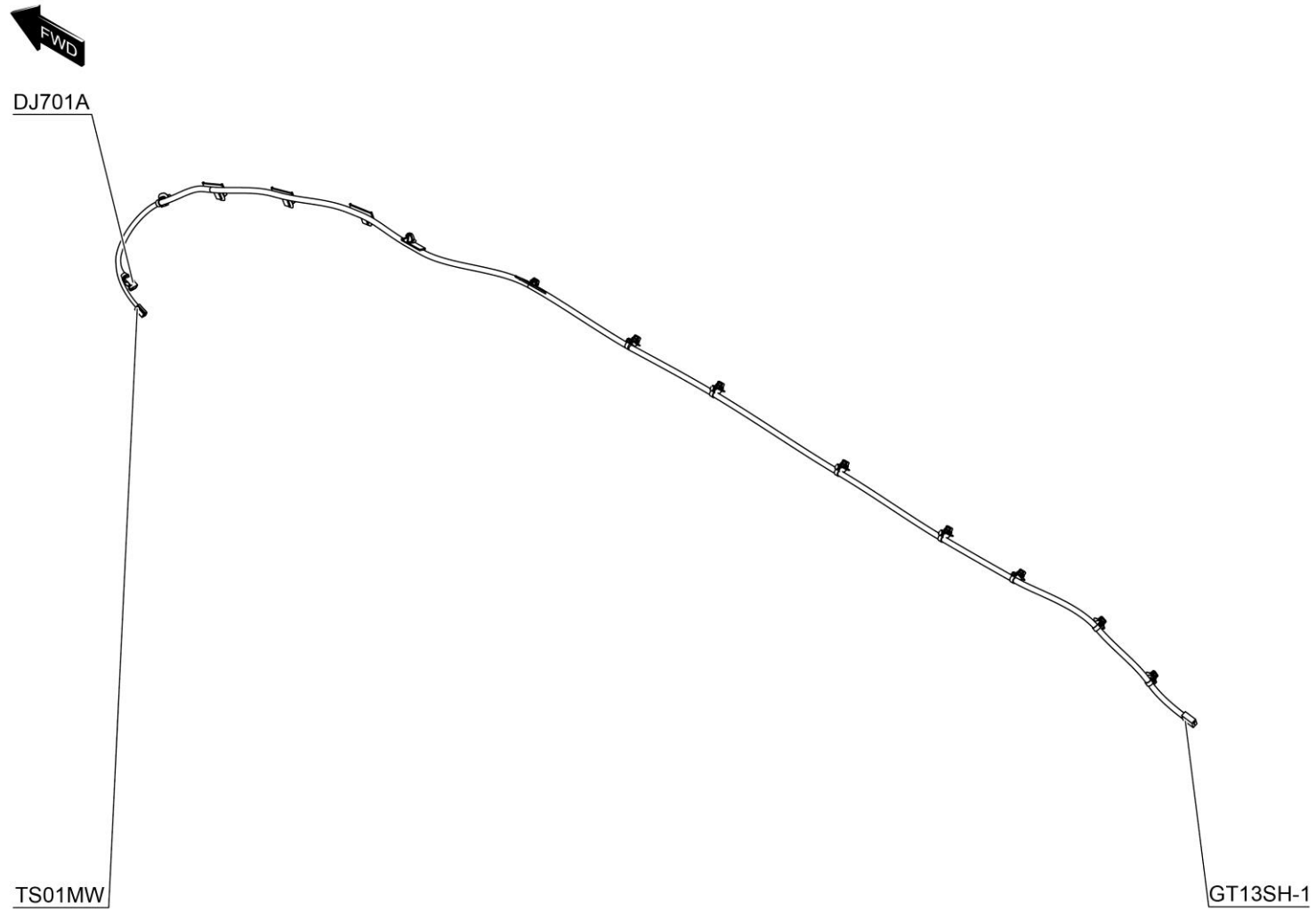



图					
序号 No.	零件编号 Part No.	名 称 Description		数量 Qty	备注 Rem
		中 文 Chinese	英 文 English		
01	DJ701A	接天线馈线 2 或 天线馈线 3			
02	GT13SH-1	接天线放大器			
03	TS01MW	接低压插件			

第四节 电器原理图

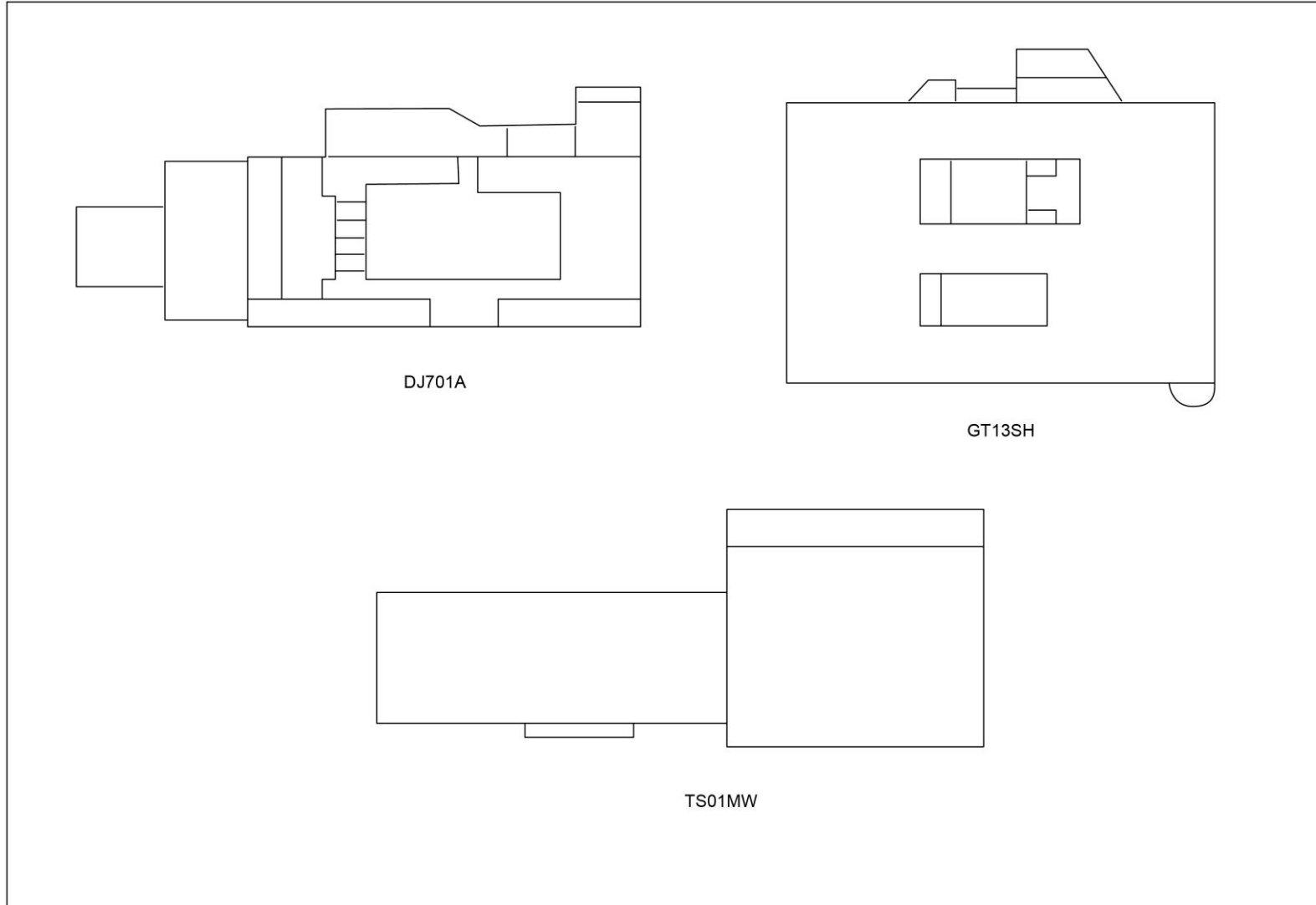

前舱配电箱

001

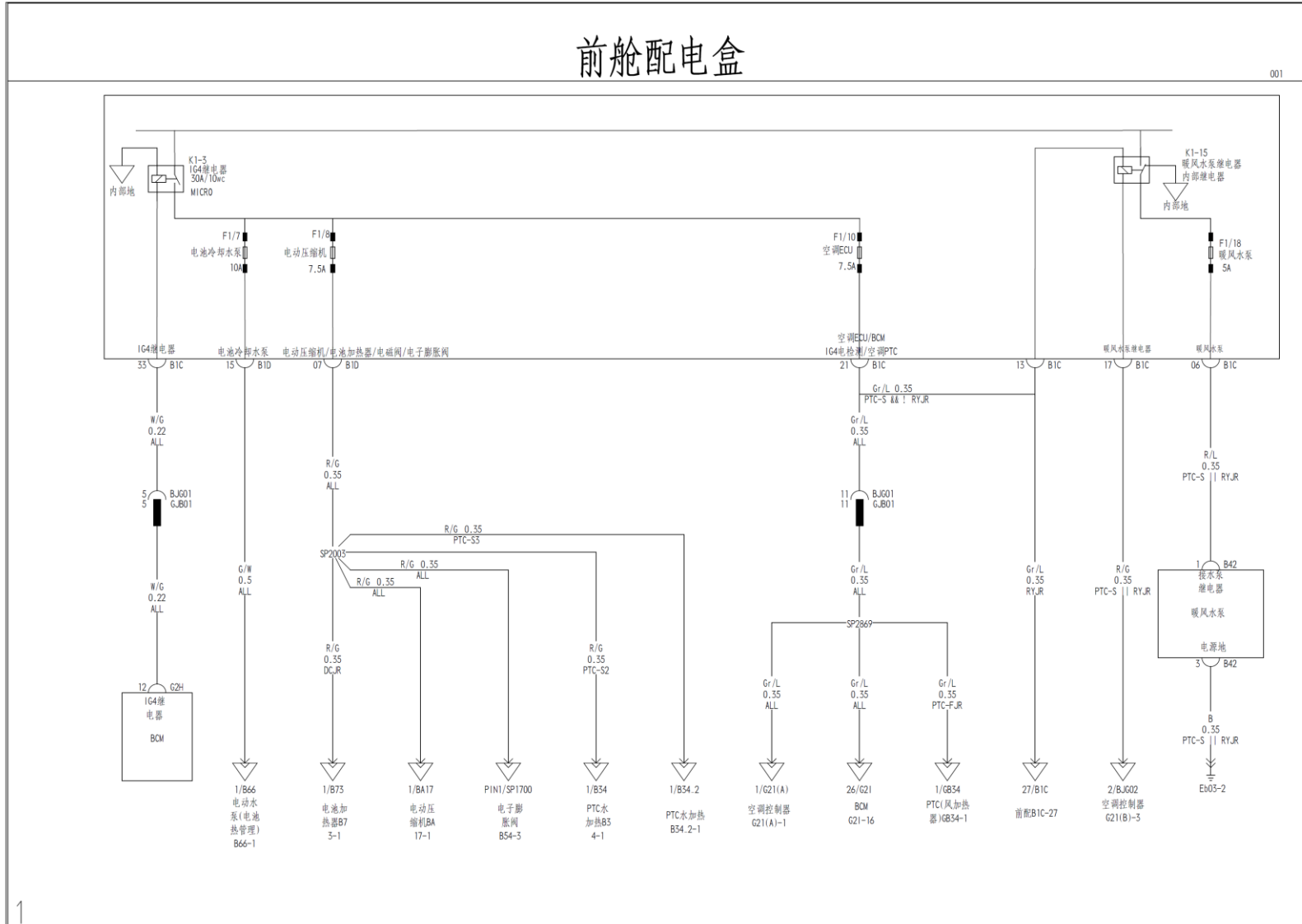



前舱配电箱

002

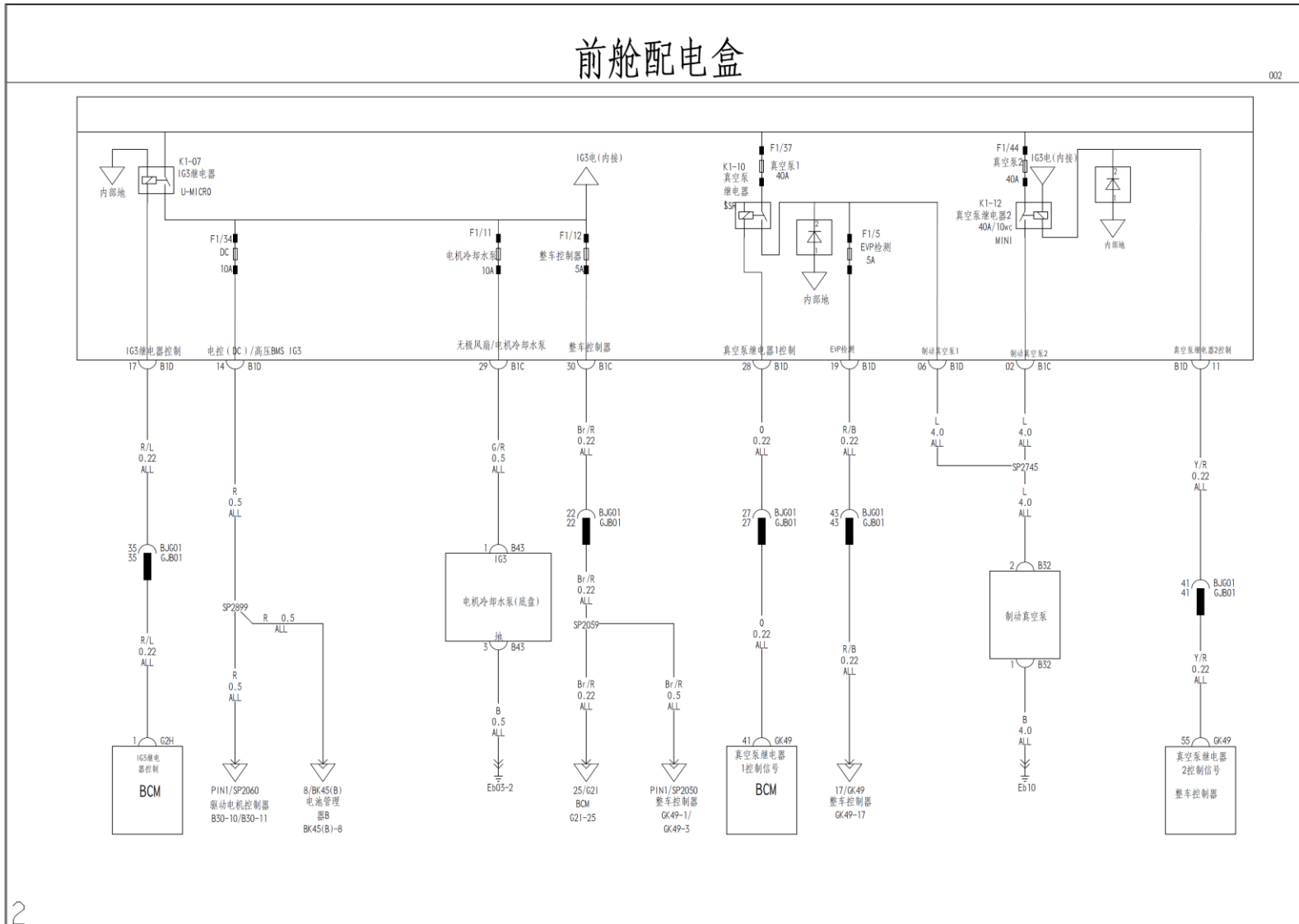



前舱配电箱

003

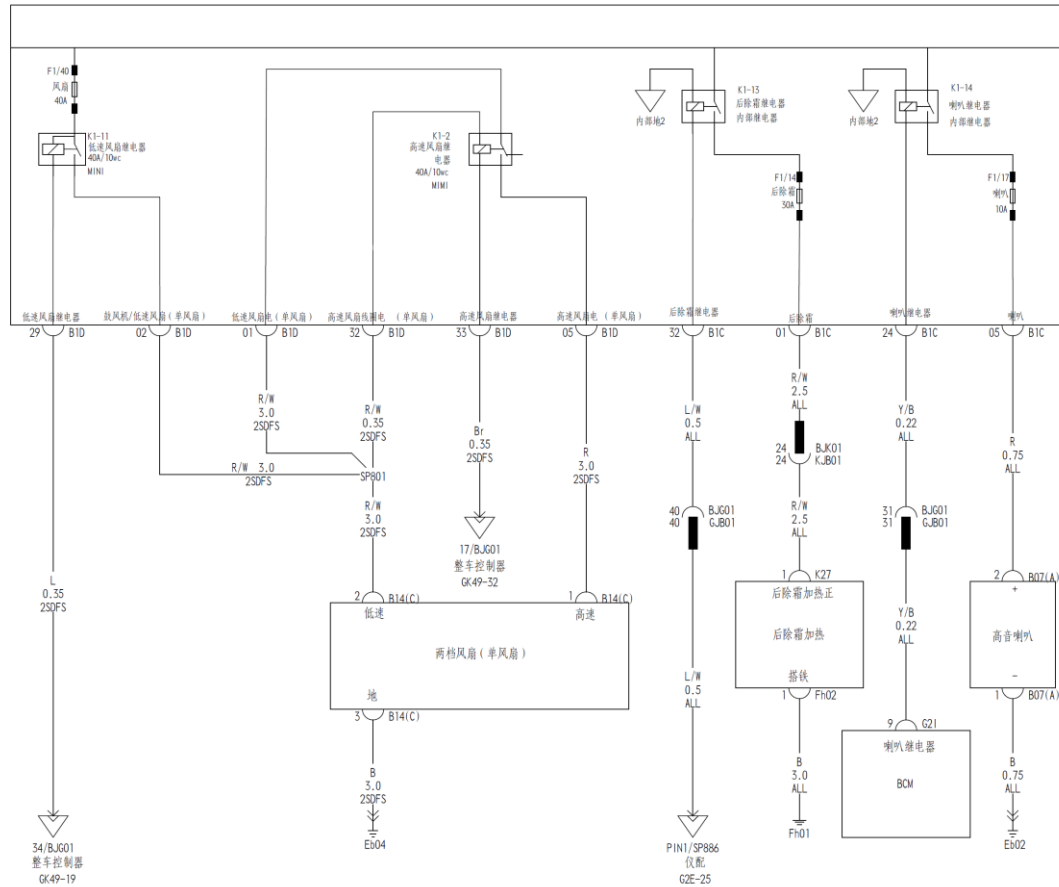

3



前舱配电箱

004

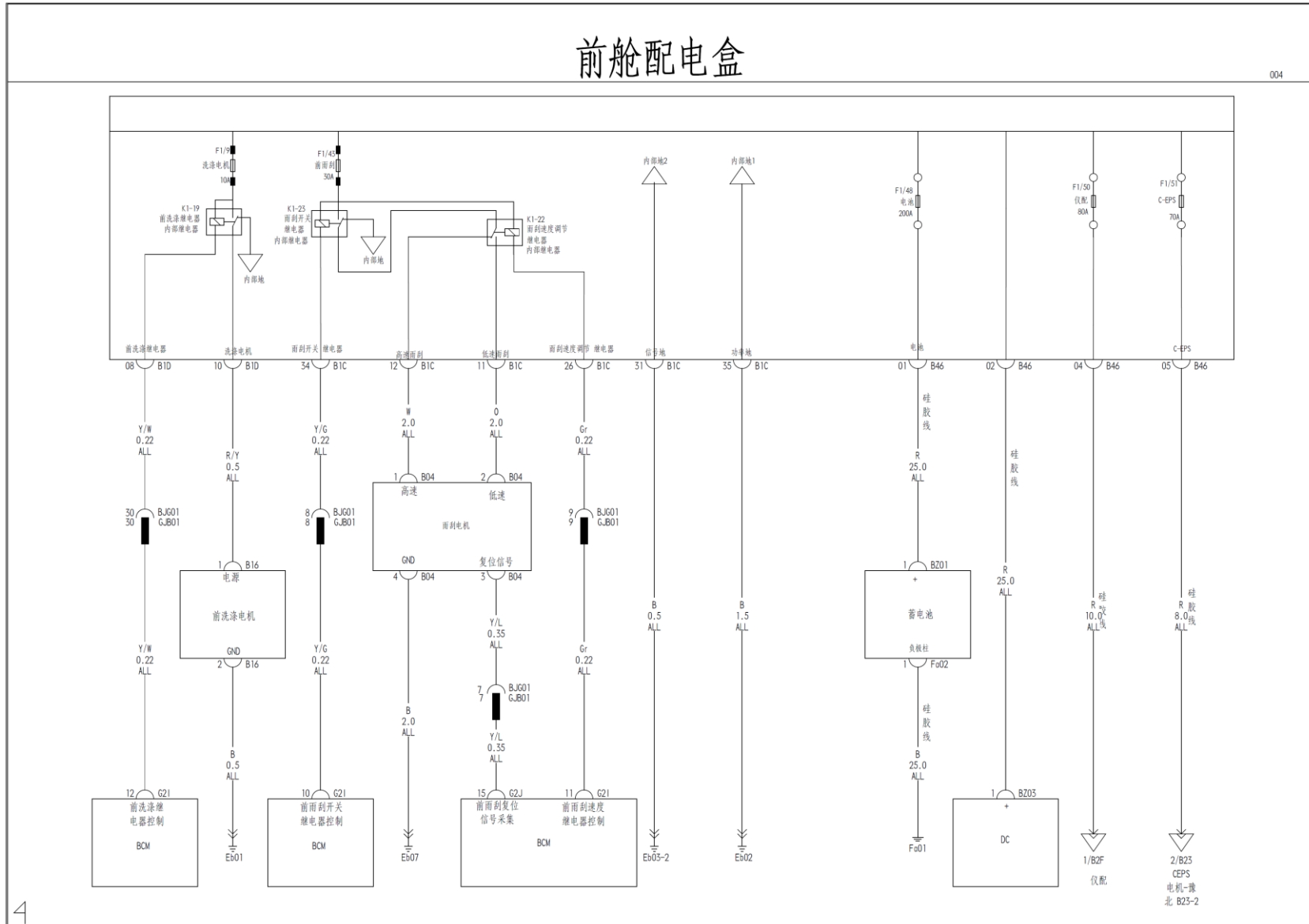

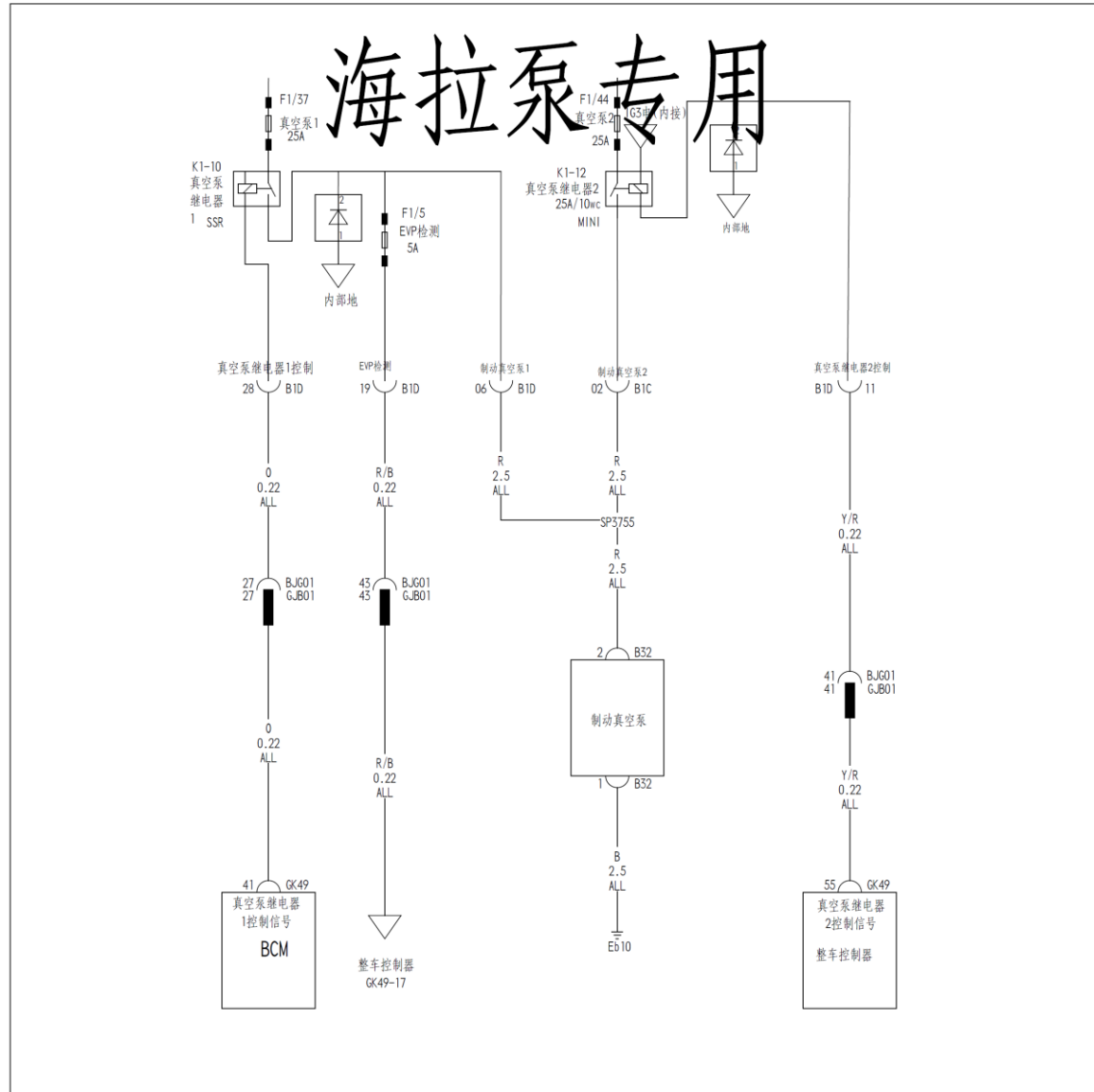



仪配 (前后USB/备用电源)

001

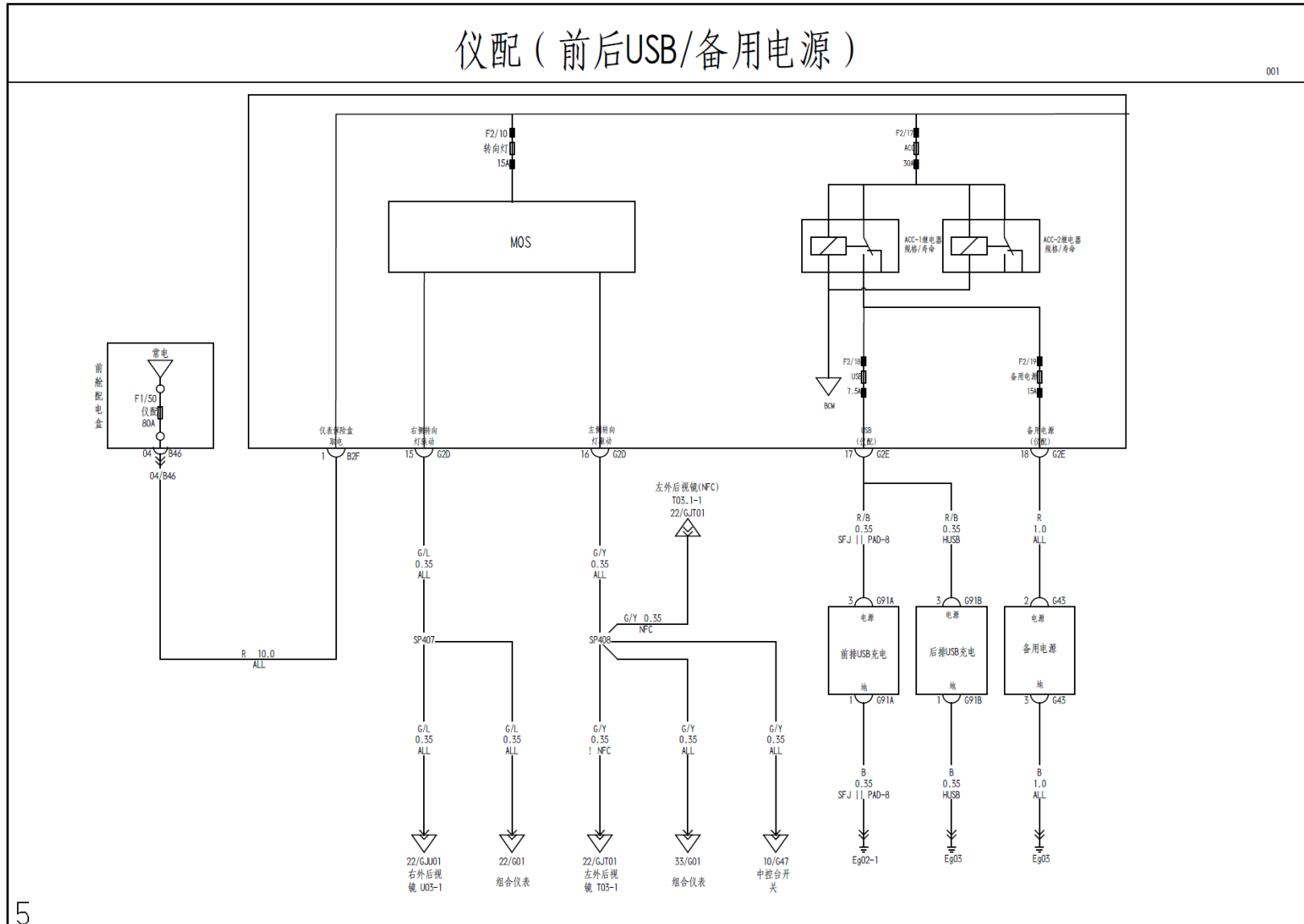

5



仪配 (座椅加热/左前门锁电机)

002

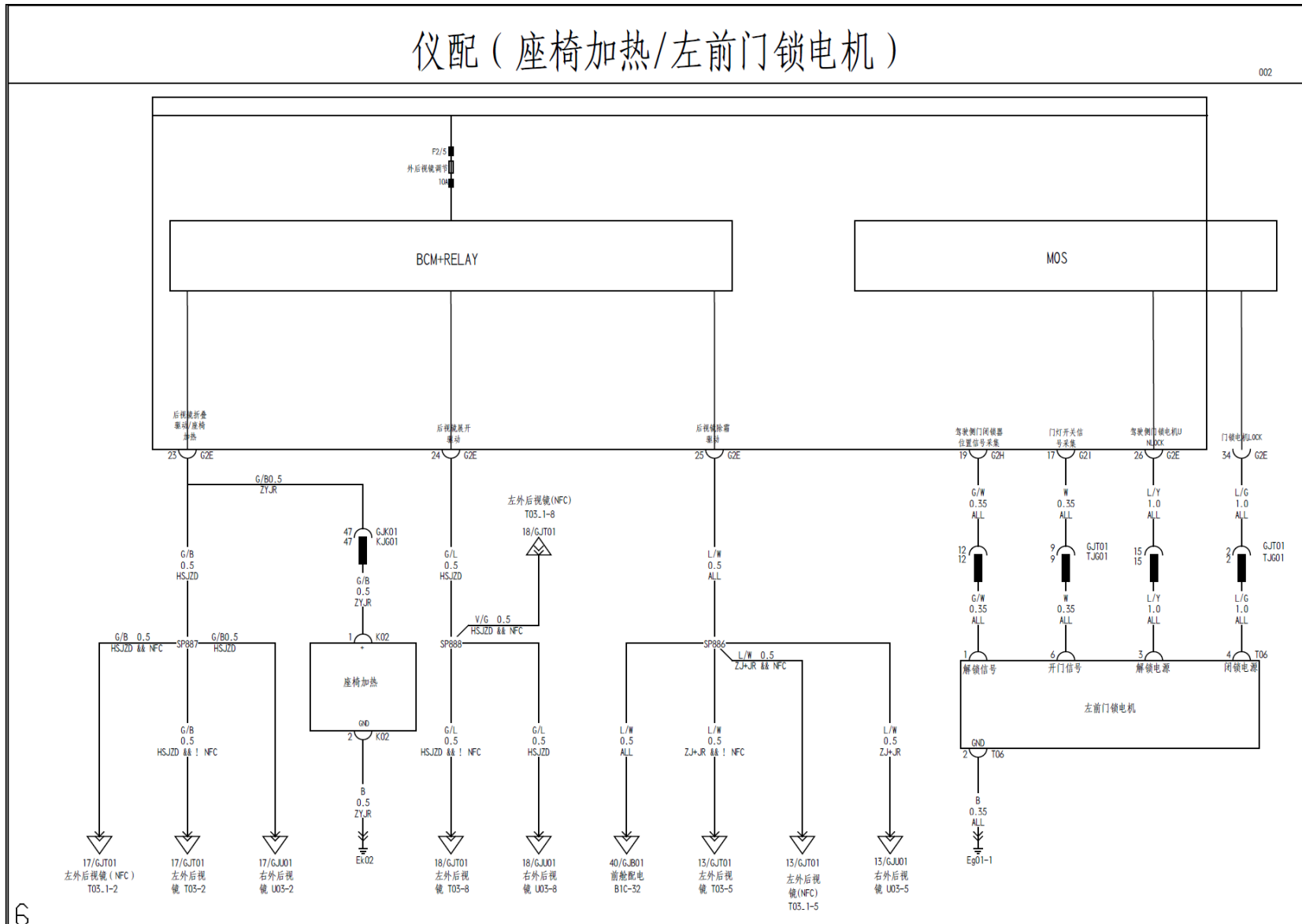

6



仪配 (右前、左后、右后、行李箱门锁电机)

005

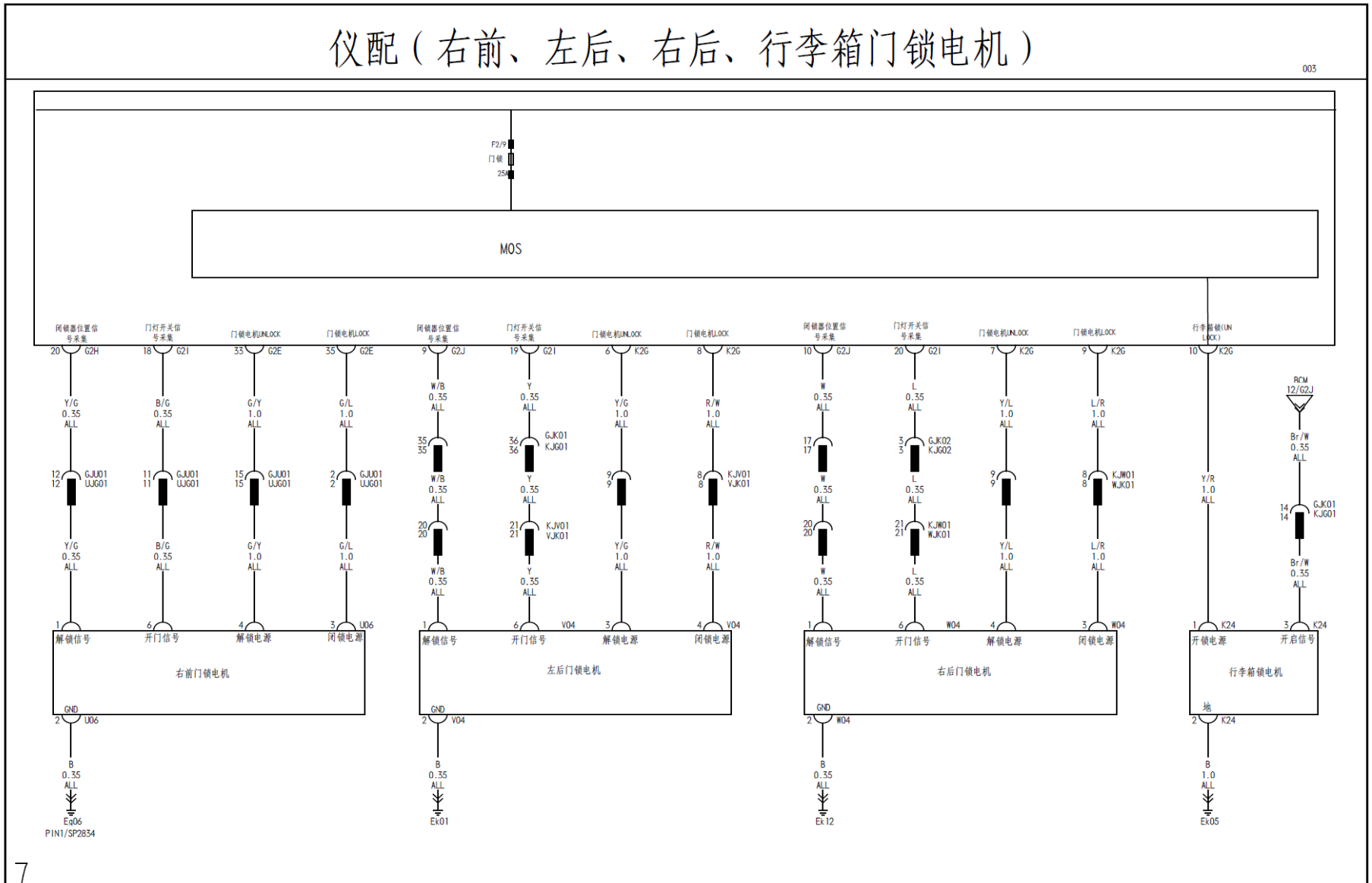

7



仪配 (充电口盖执行器/主驾座椅)

004

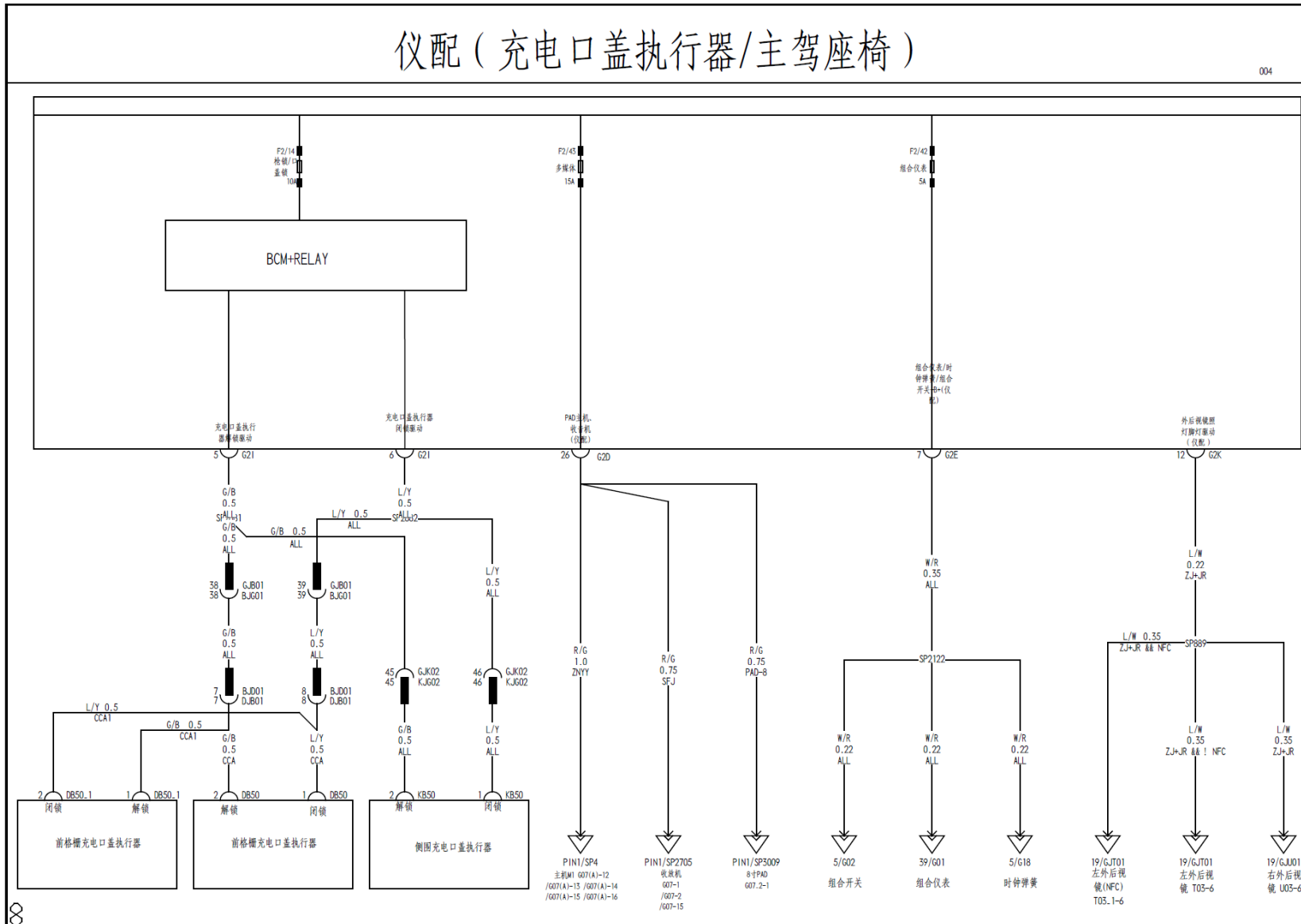



仪配/胎压监测模块

005

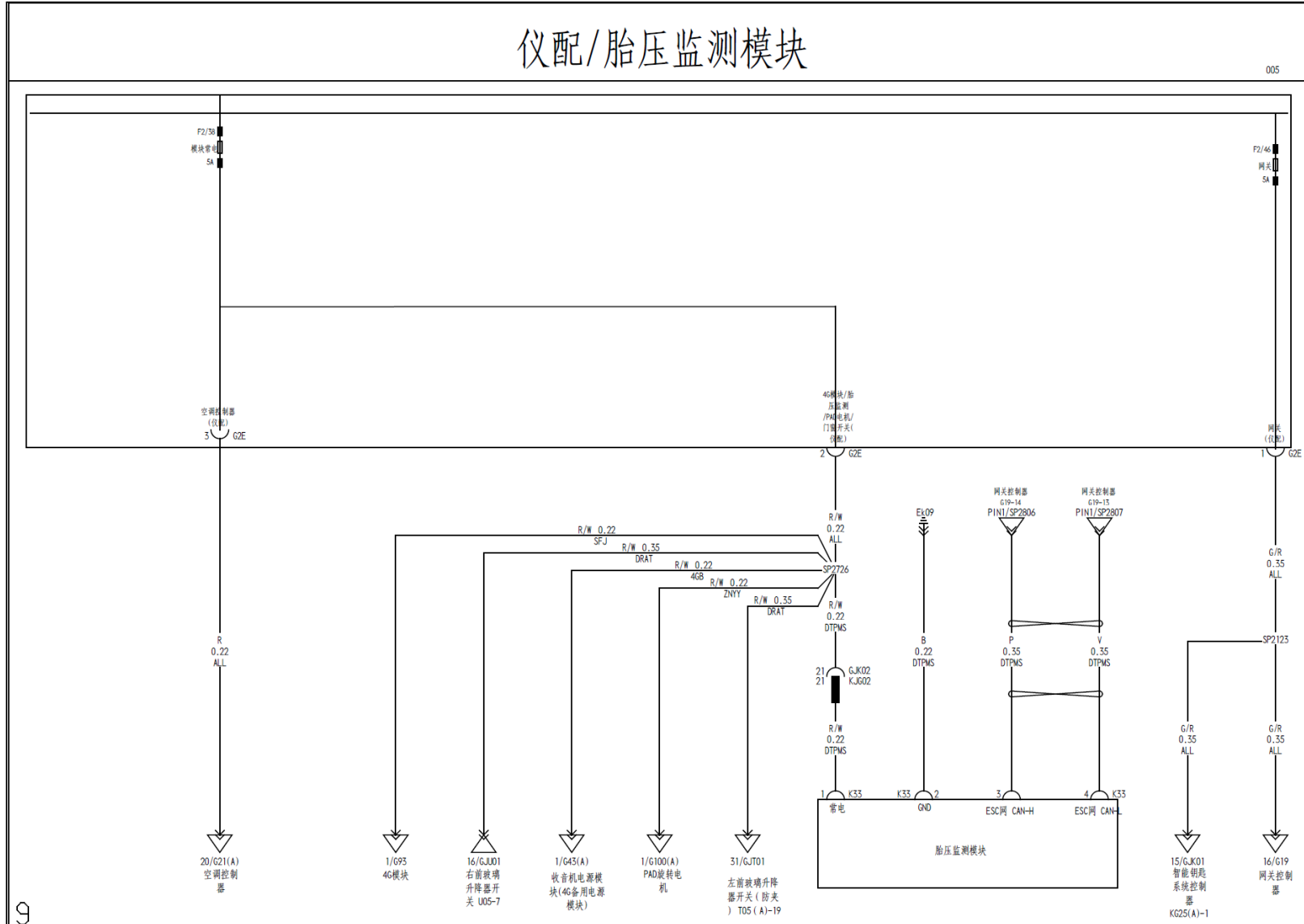

仪配

006

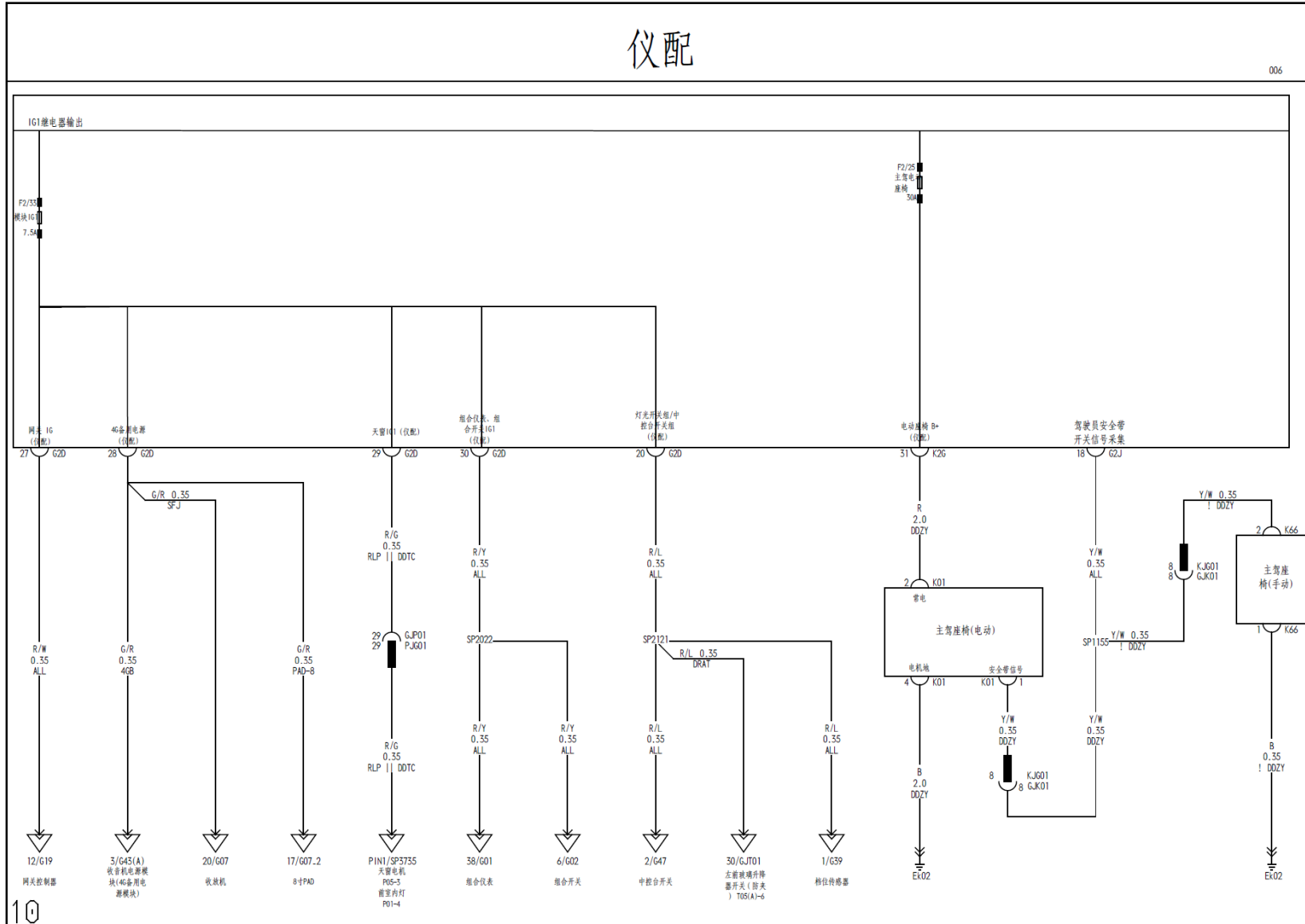

10



BCM/启动按钮 (副驾安全带扣/副驾安全带报警传感器/前舱盖微动开关)

007

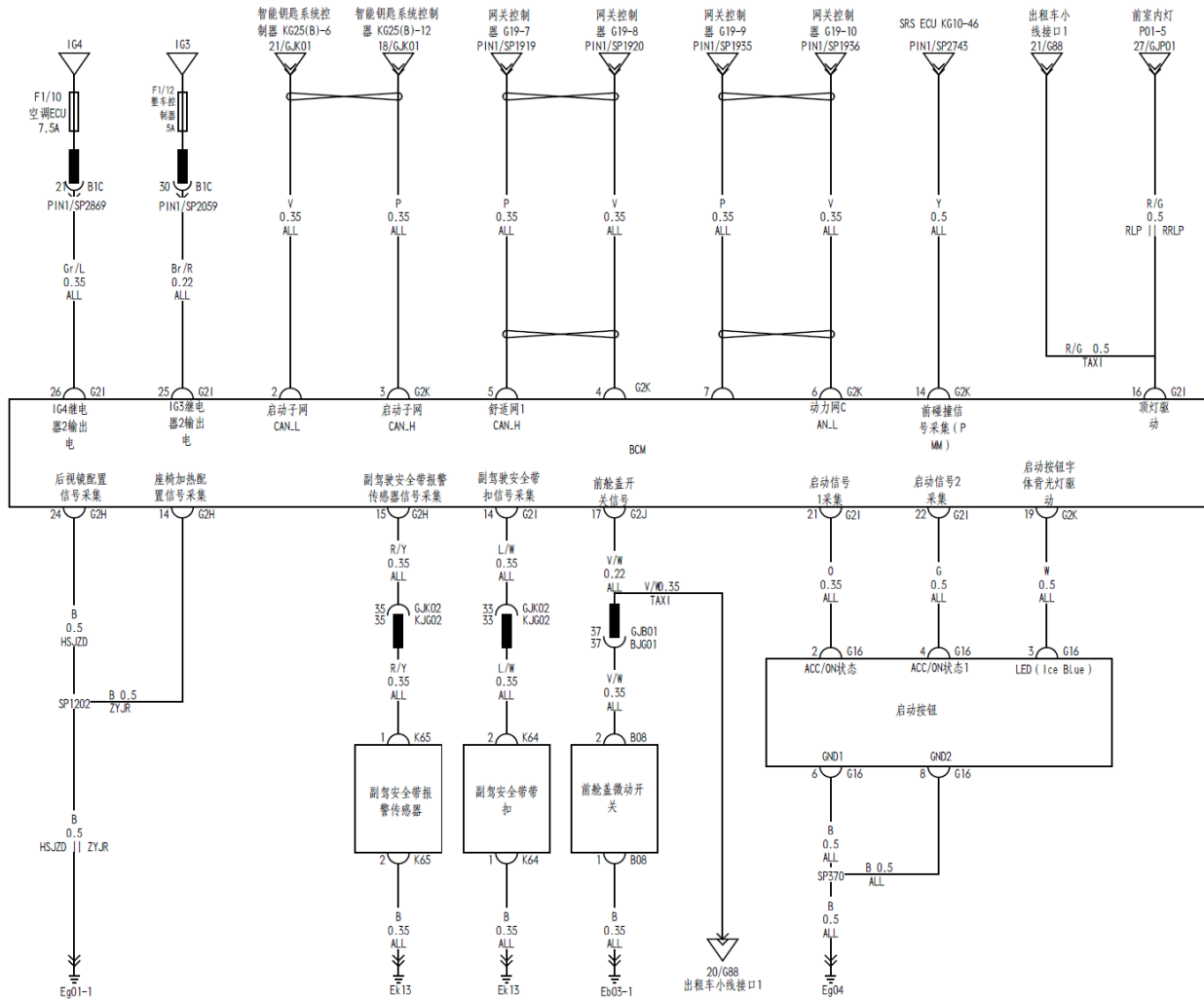

BCM/制动灯开关/充电口照明灯

008

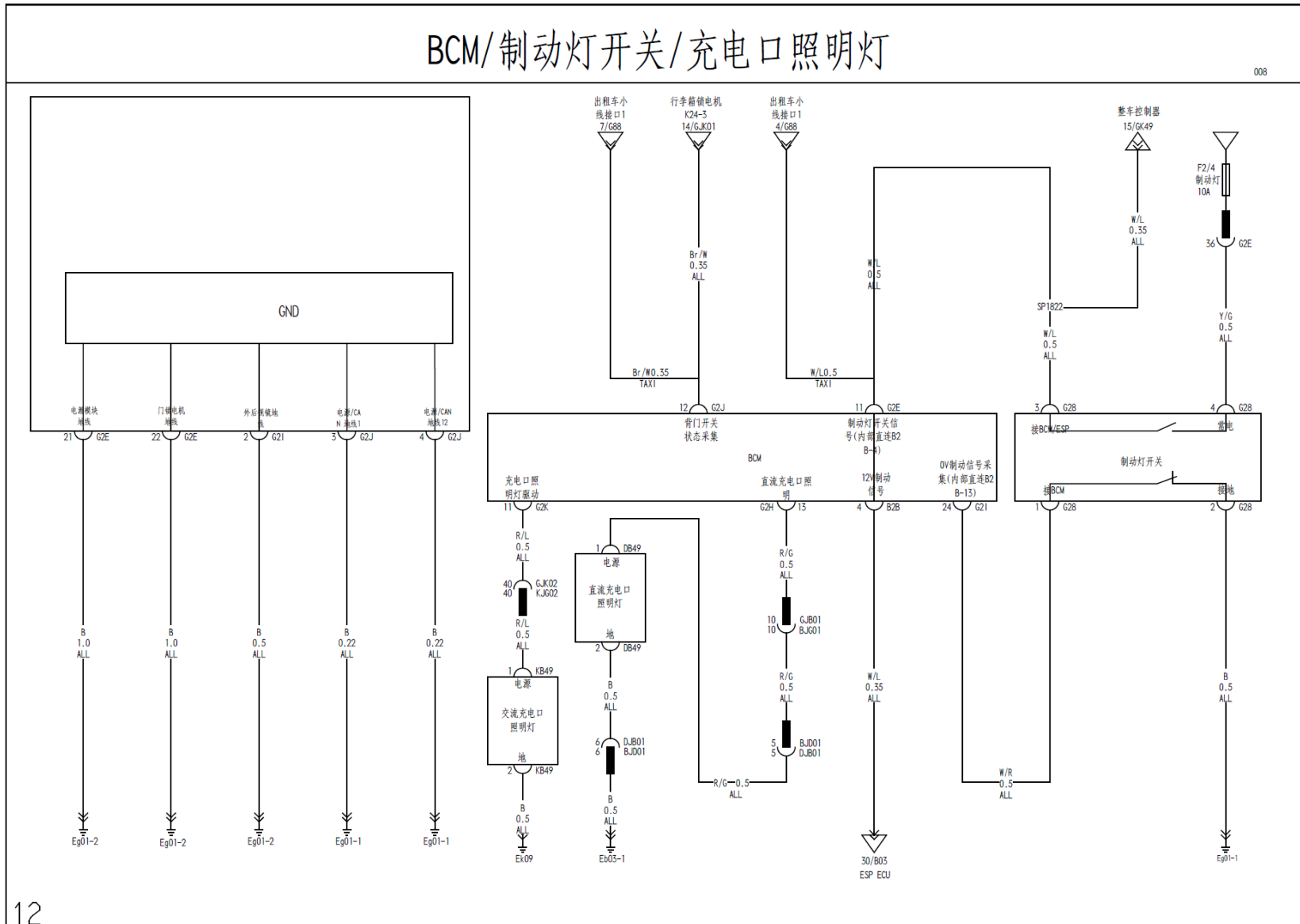



PAD主机 (音量旋钮)

001

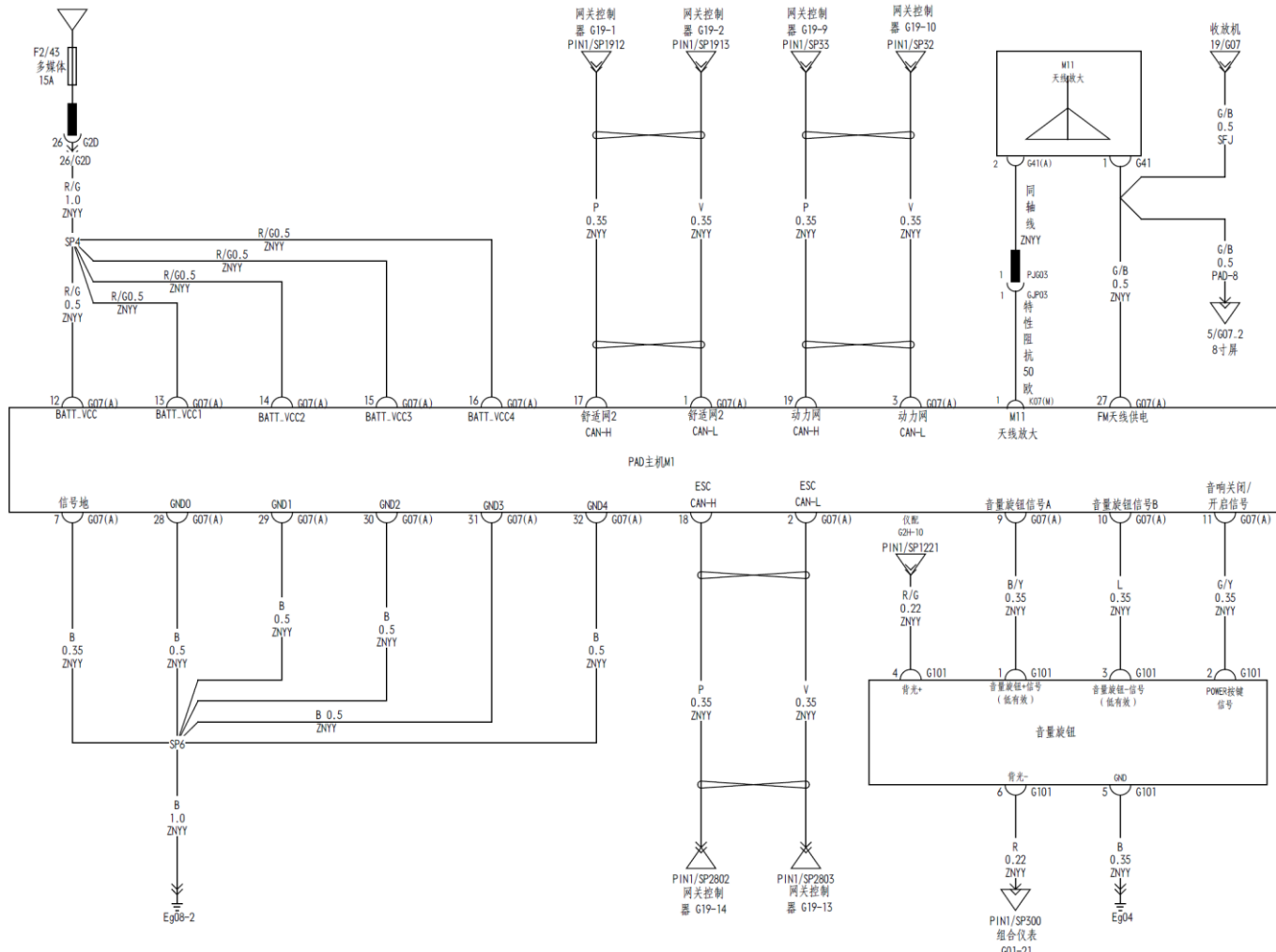

PAD主机 (倒车、右前摄像头、PAD旋转电机)

002

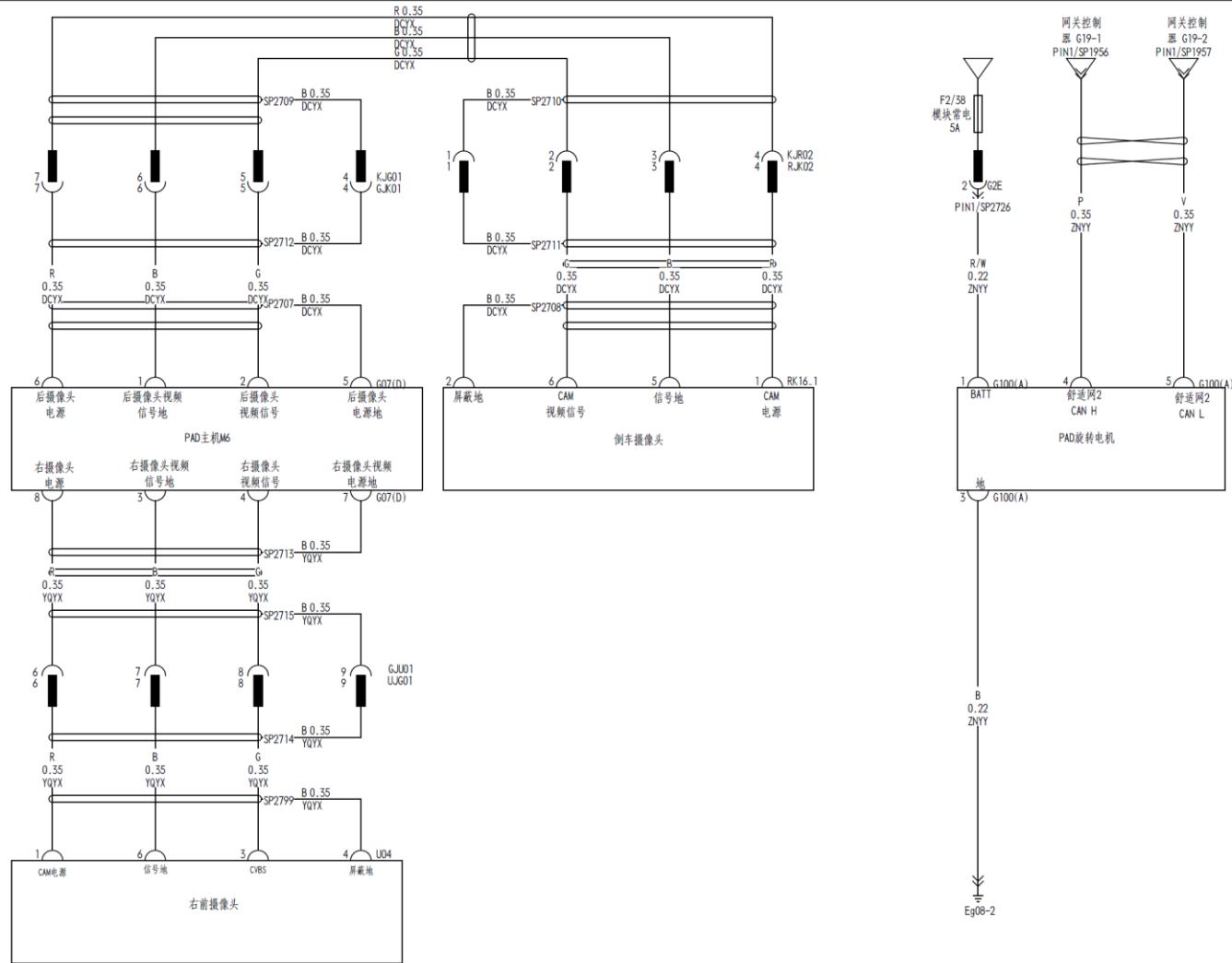



PAD主机 (扬声器、收音机)

003

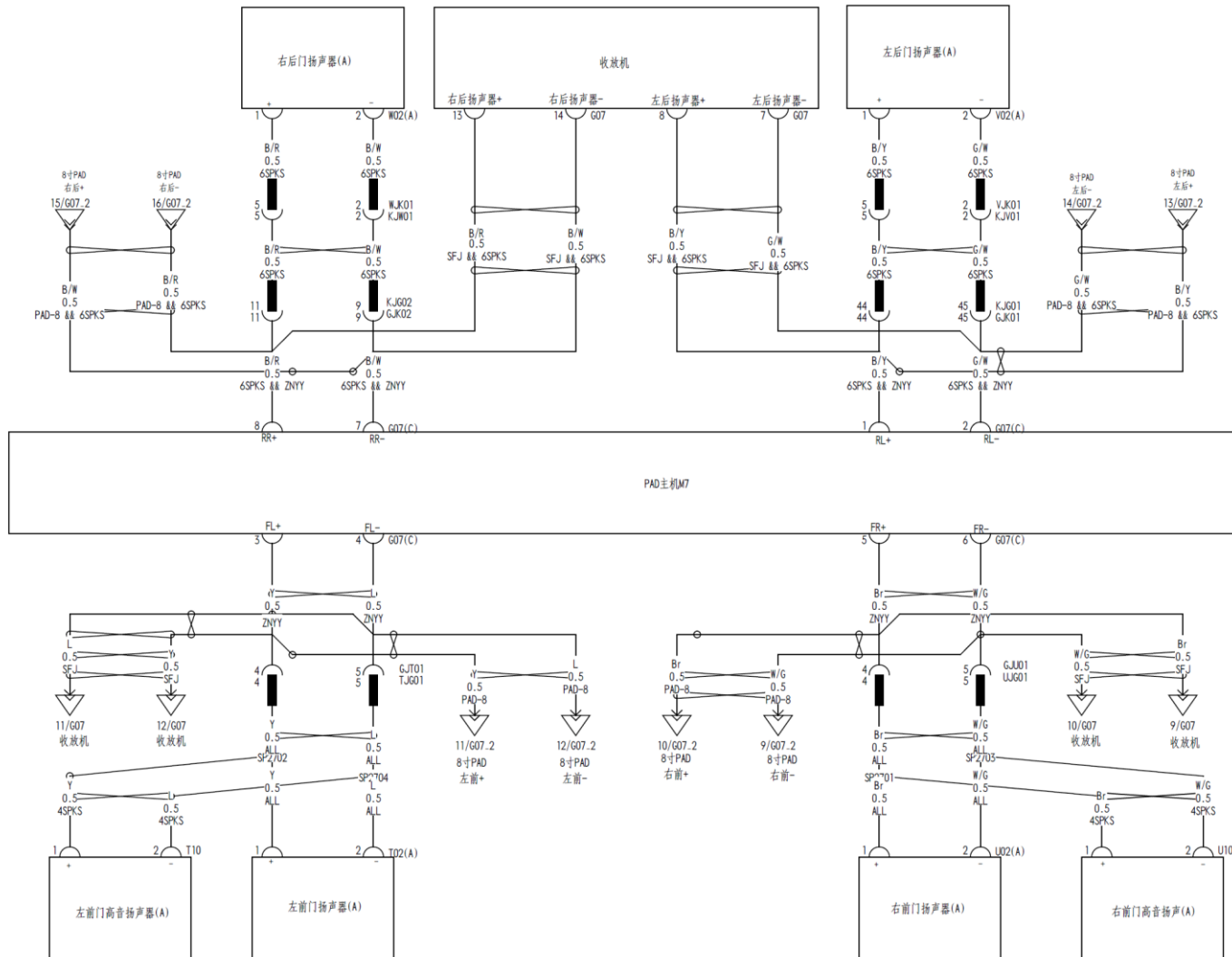

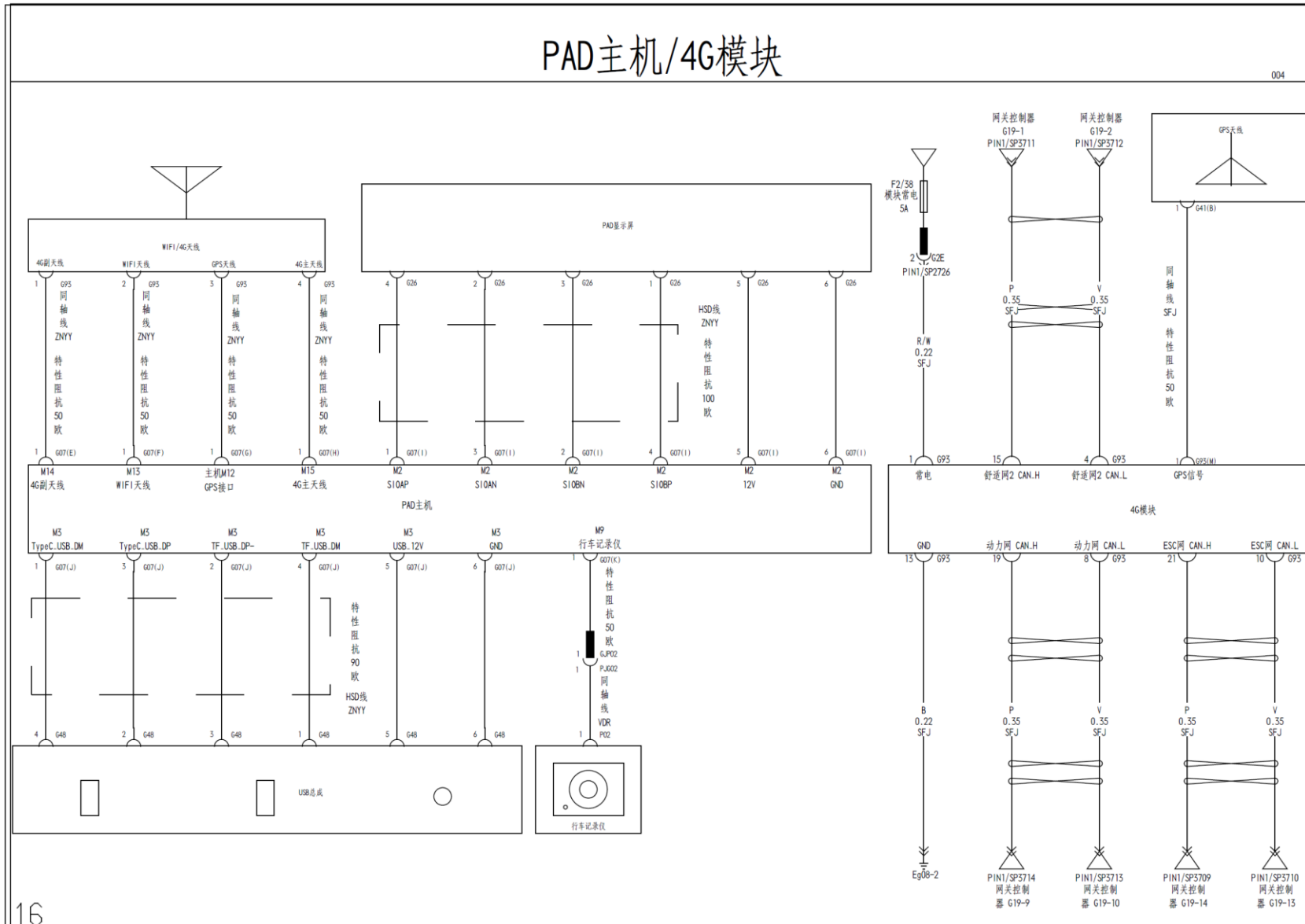

收音机/4G备用电源模块/8寸屏

005

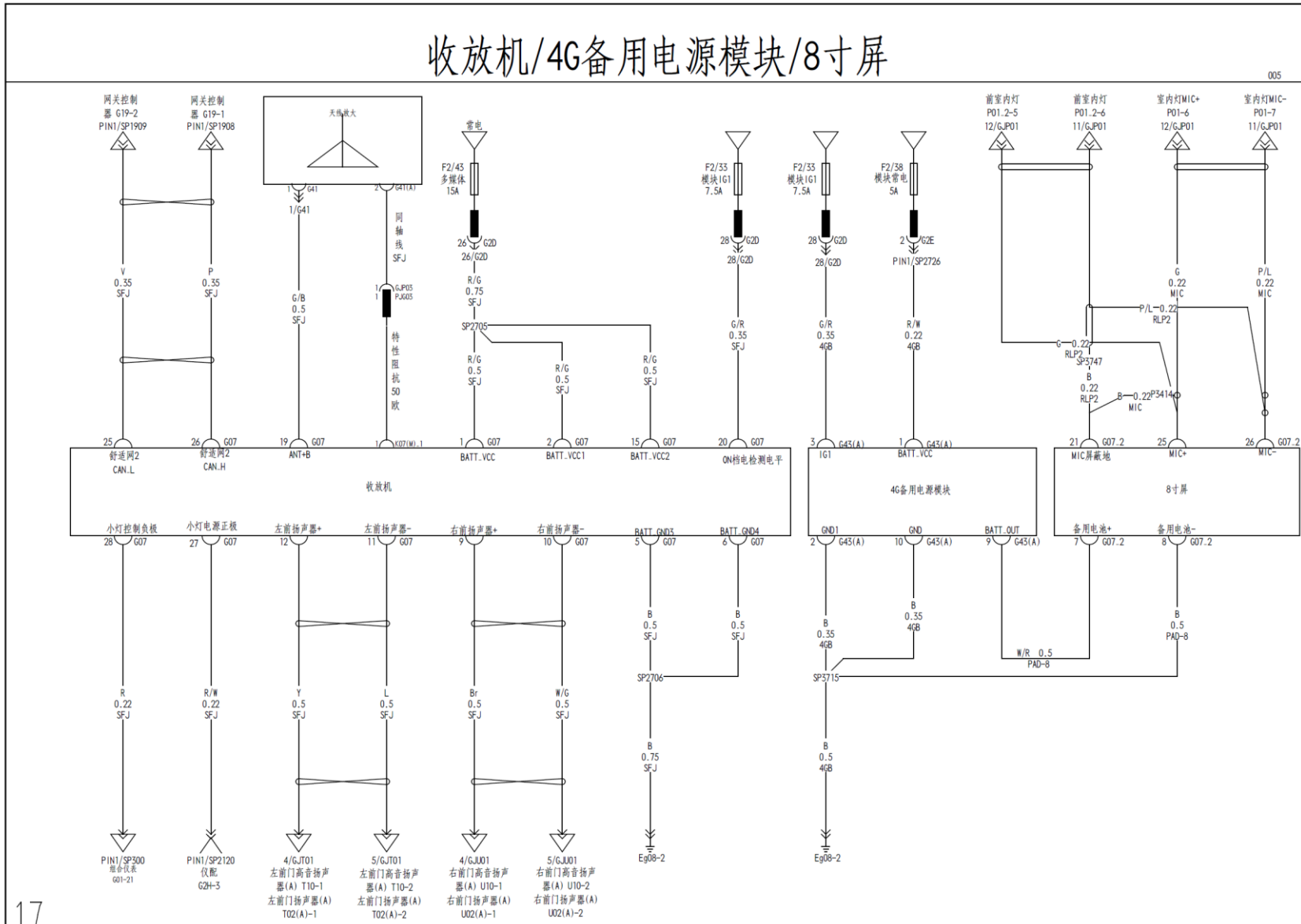

17

8寸屏/倒车摄像头/音量旋钮

006

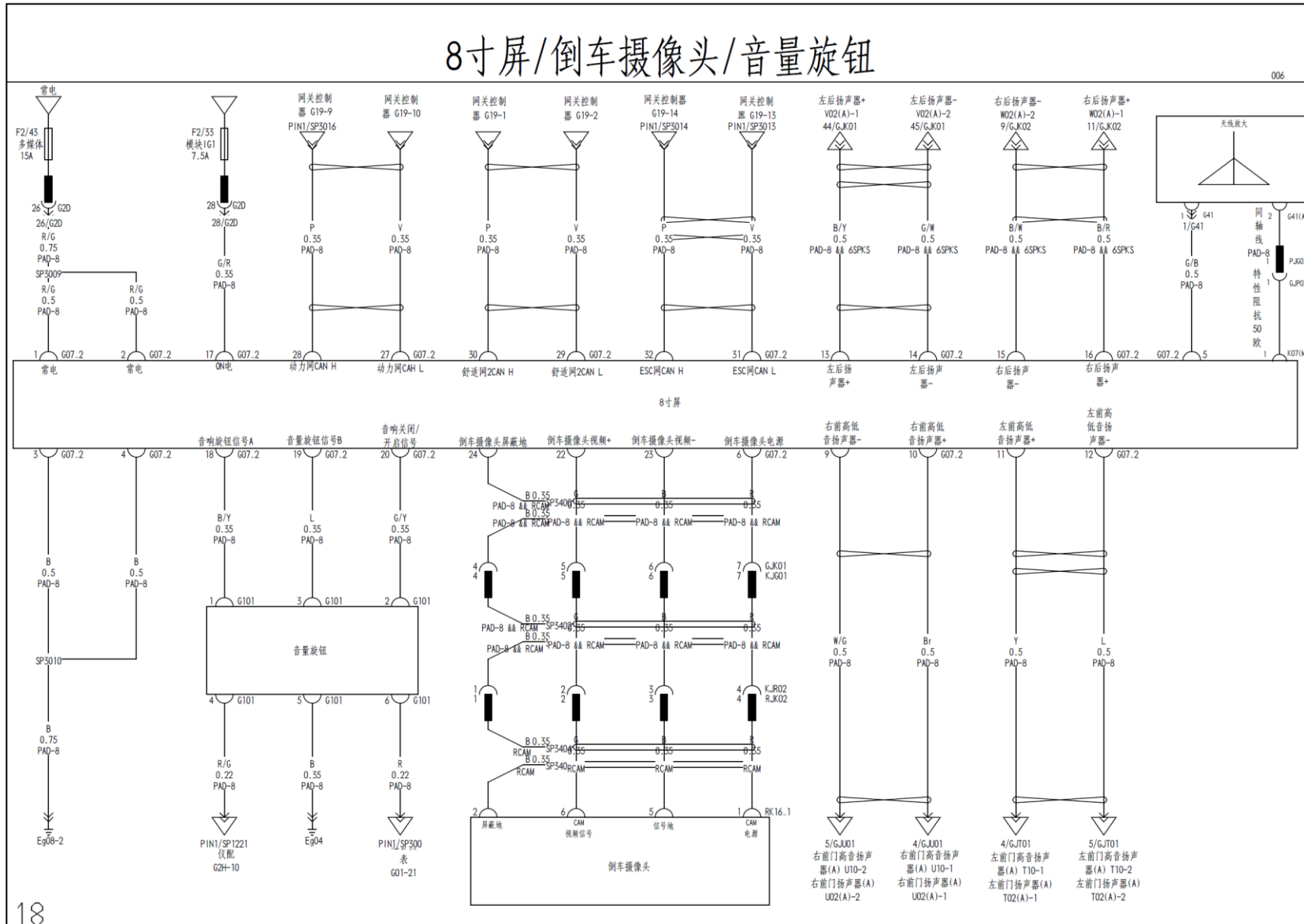



智能钥匙系统控制器（蓄电池BMS/探测天线）

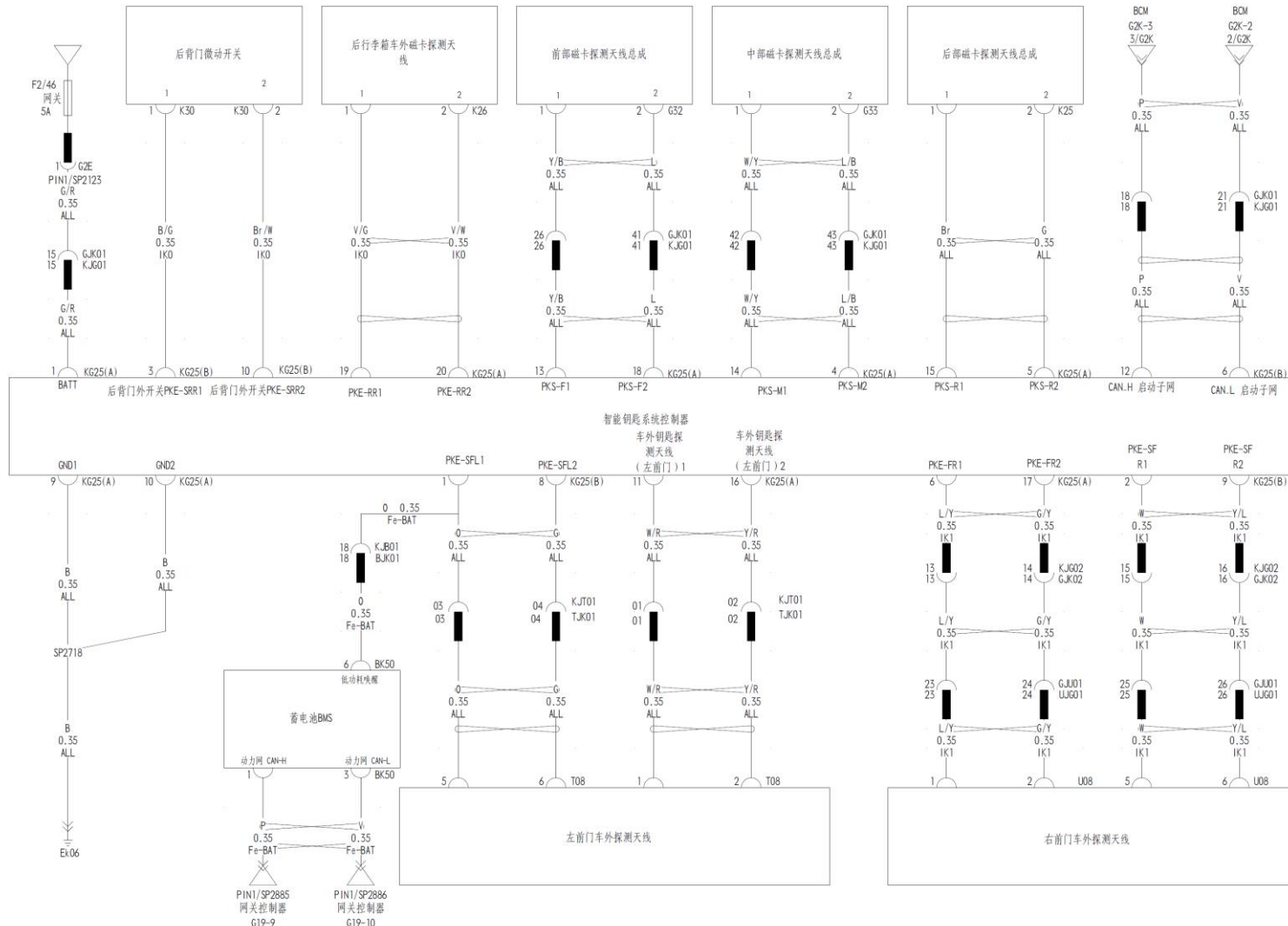



组合仪表(引擎音模拟器/制动液位开关)

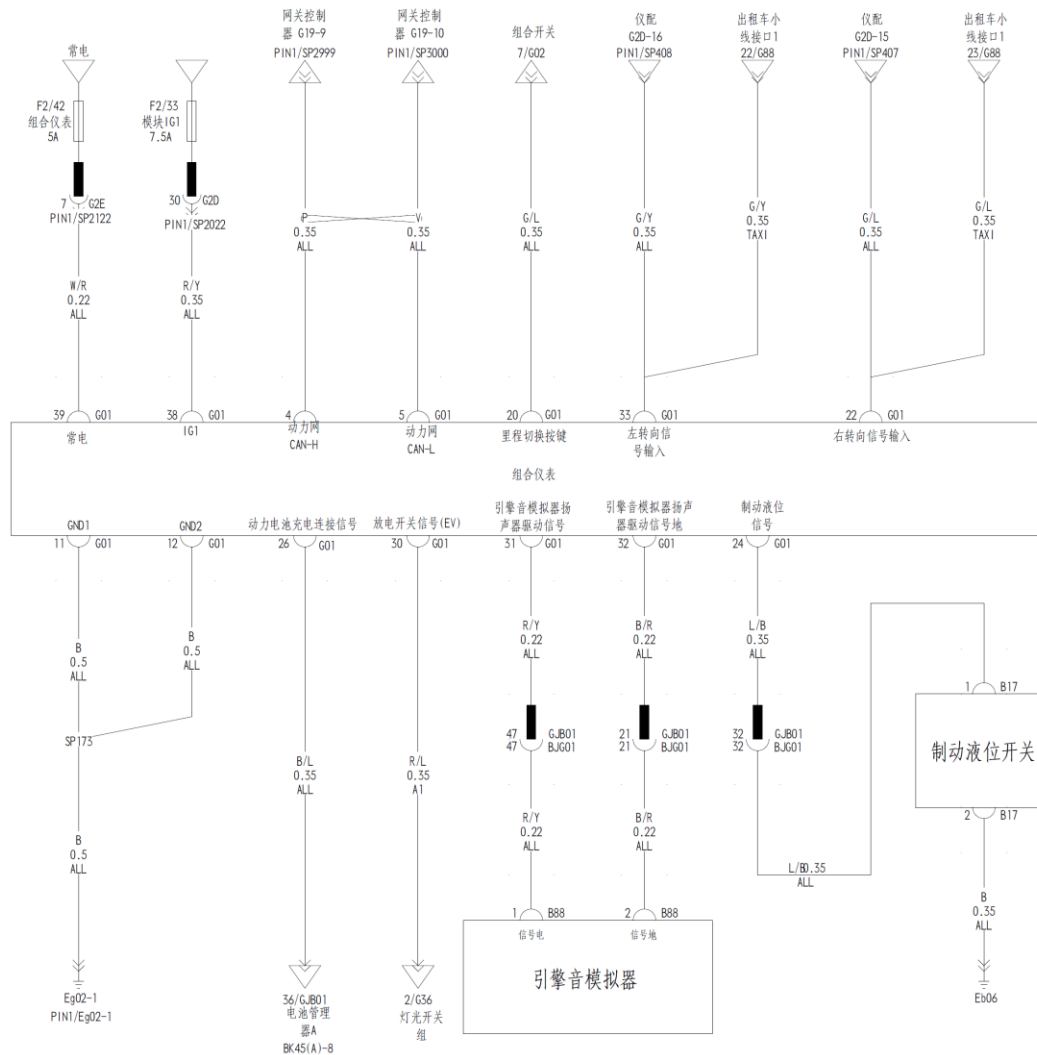

驻车辅助ECU

001

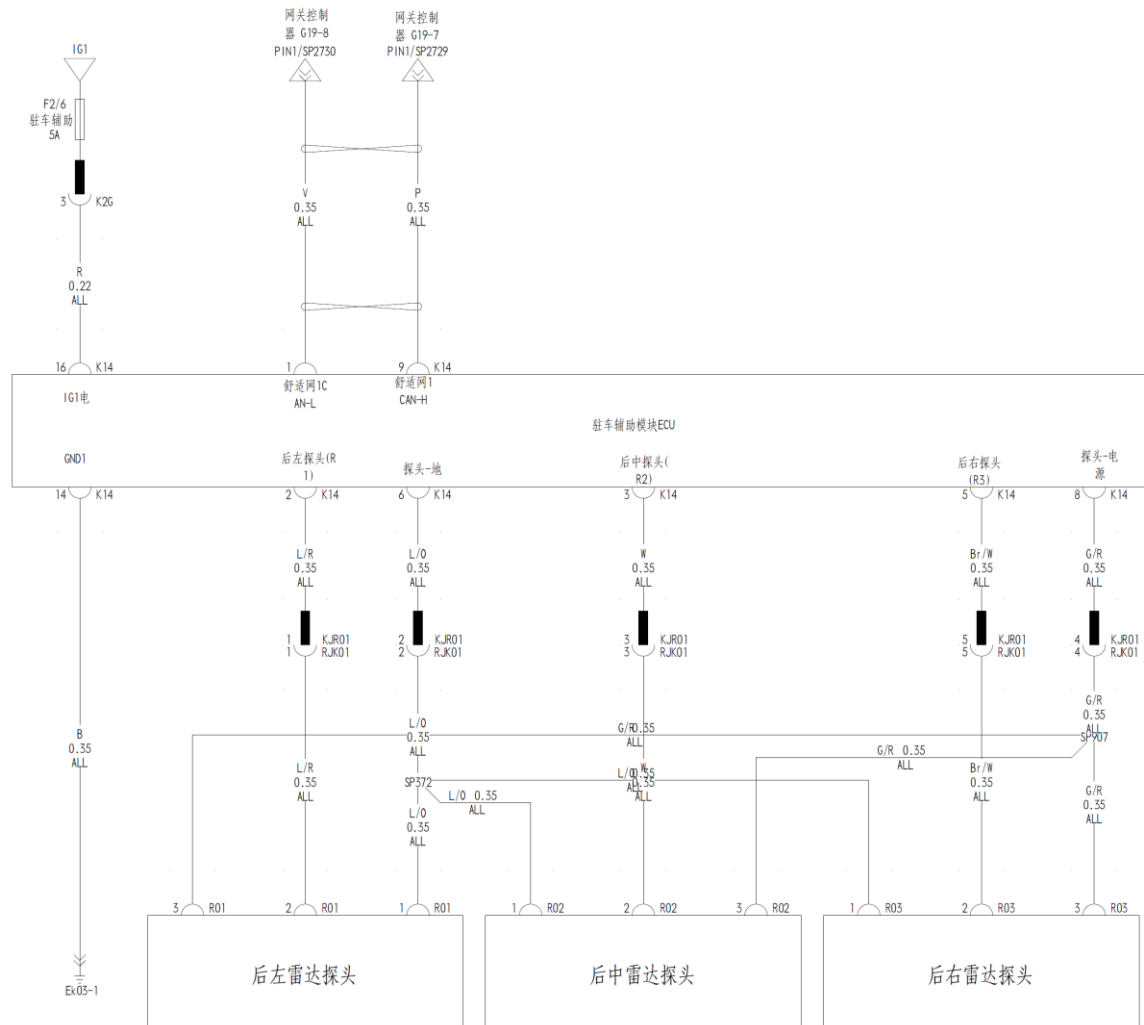

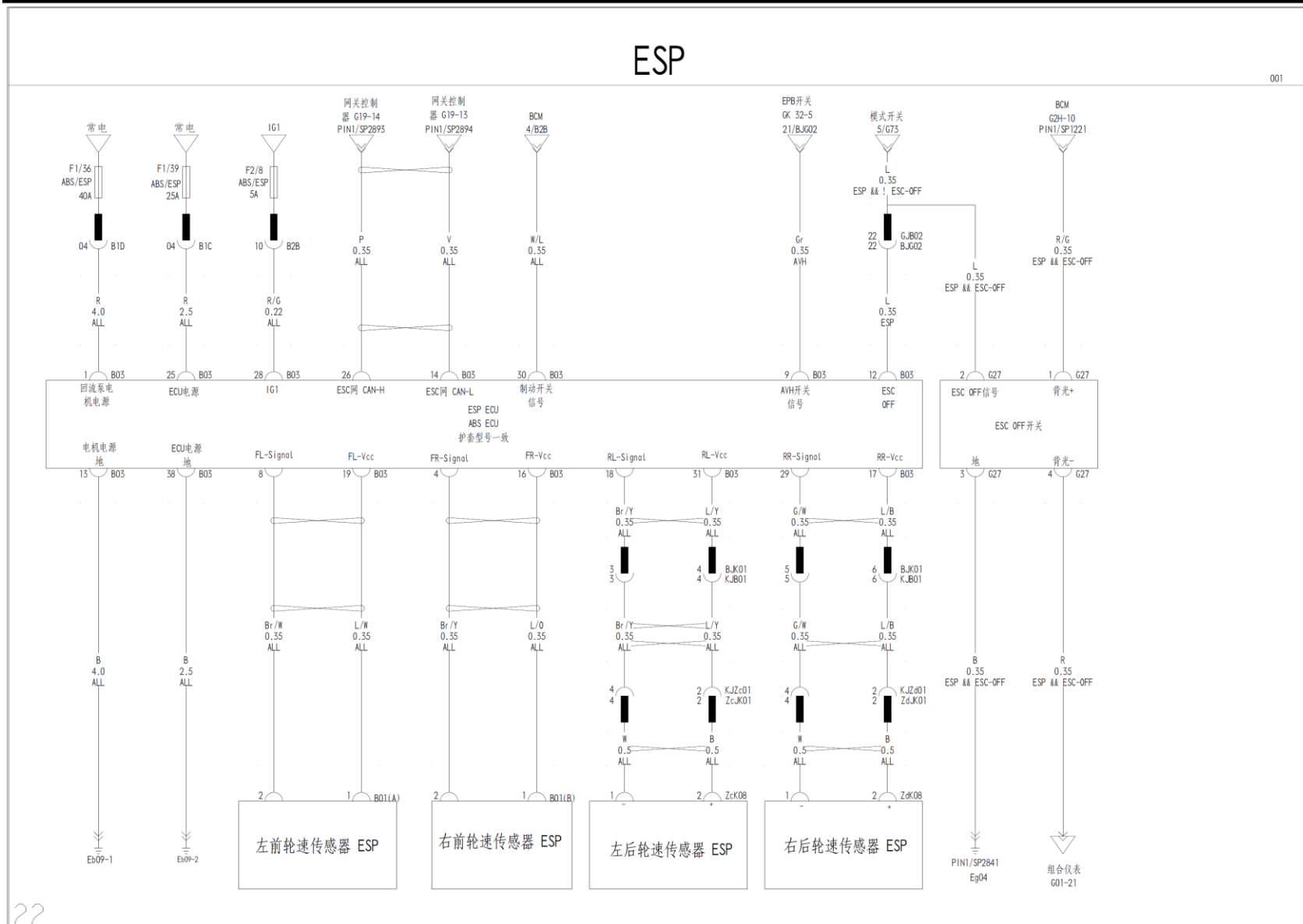

22



EPB ECU

001

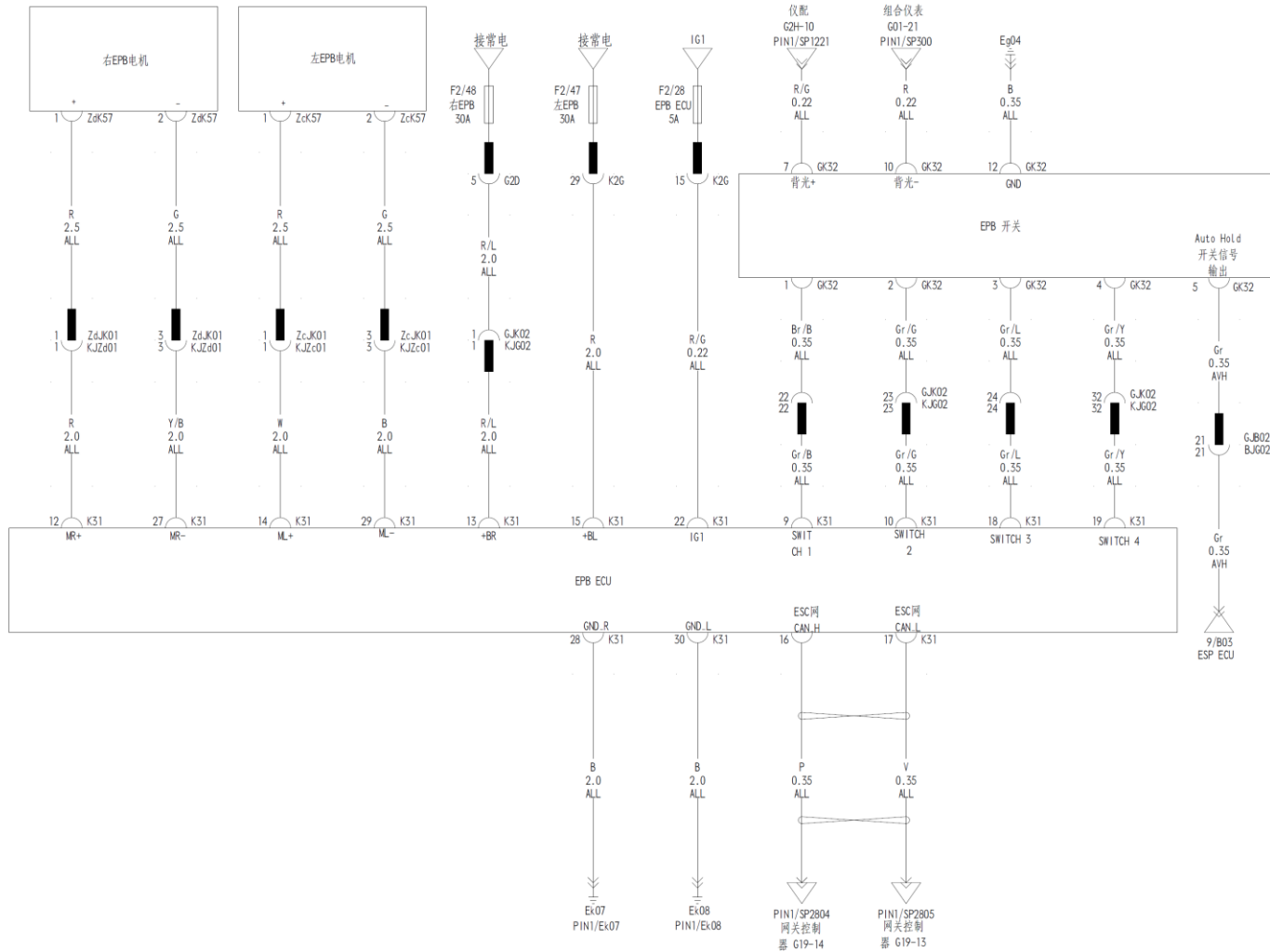

气囊ECU (气囊)

001

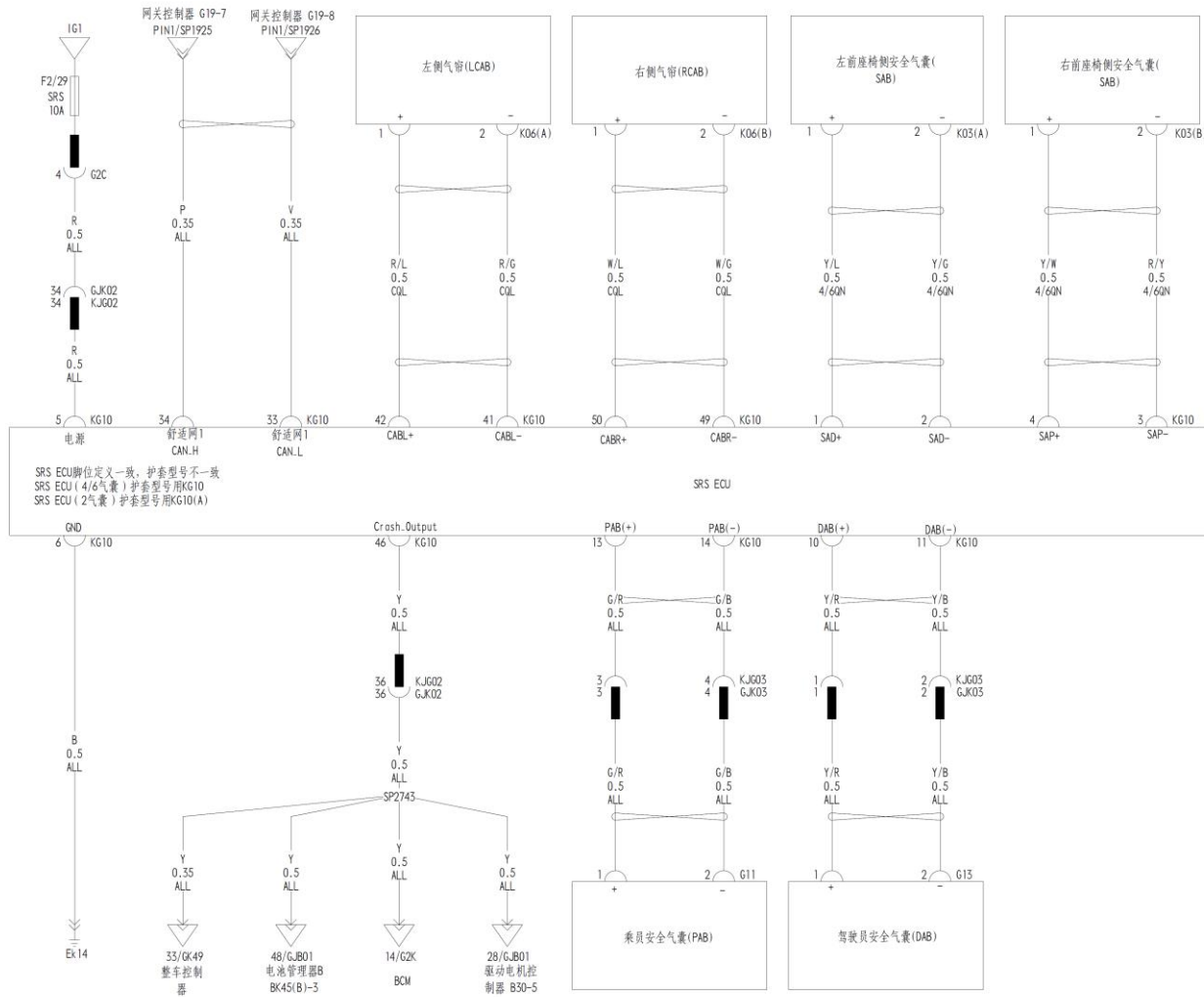

气囊ECU (碰撞传感器) / 时钟弹簧

002

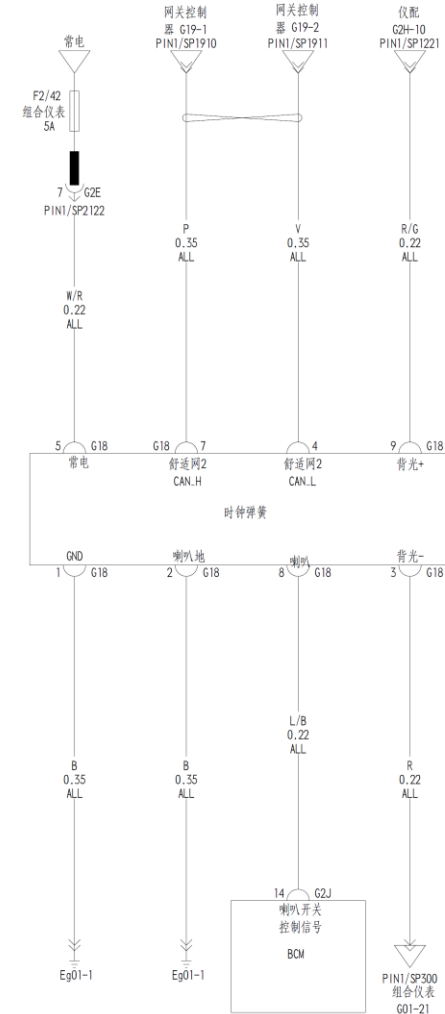
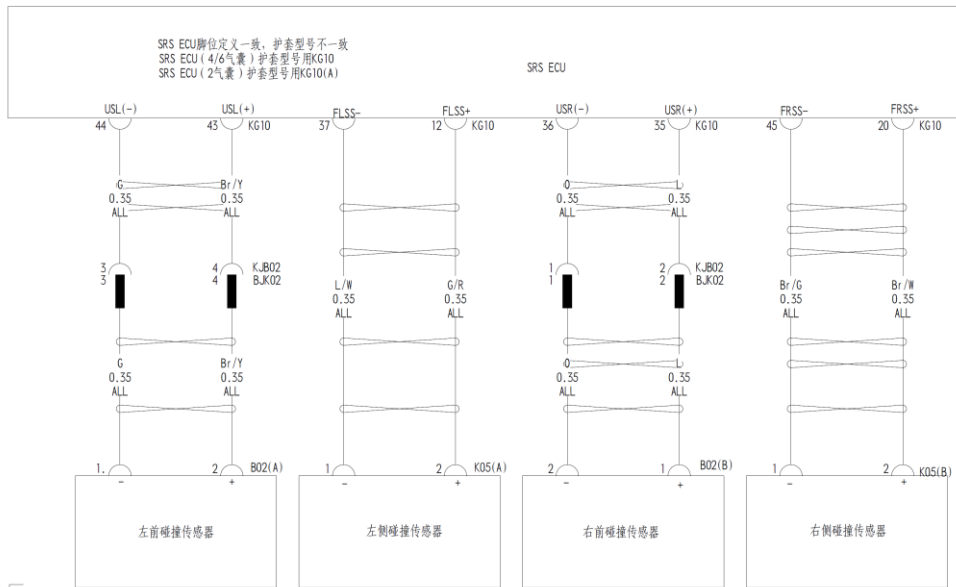

25



CEPS/诊断口

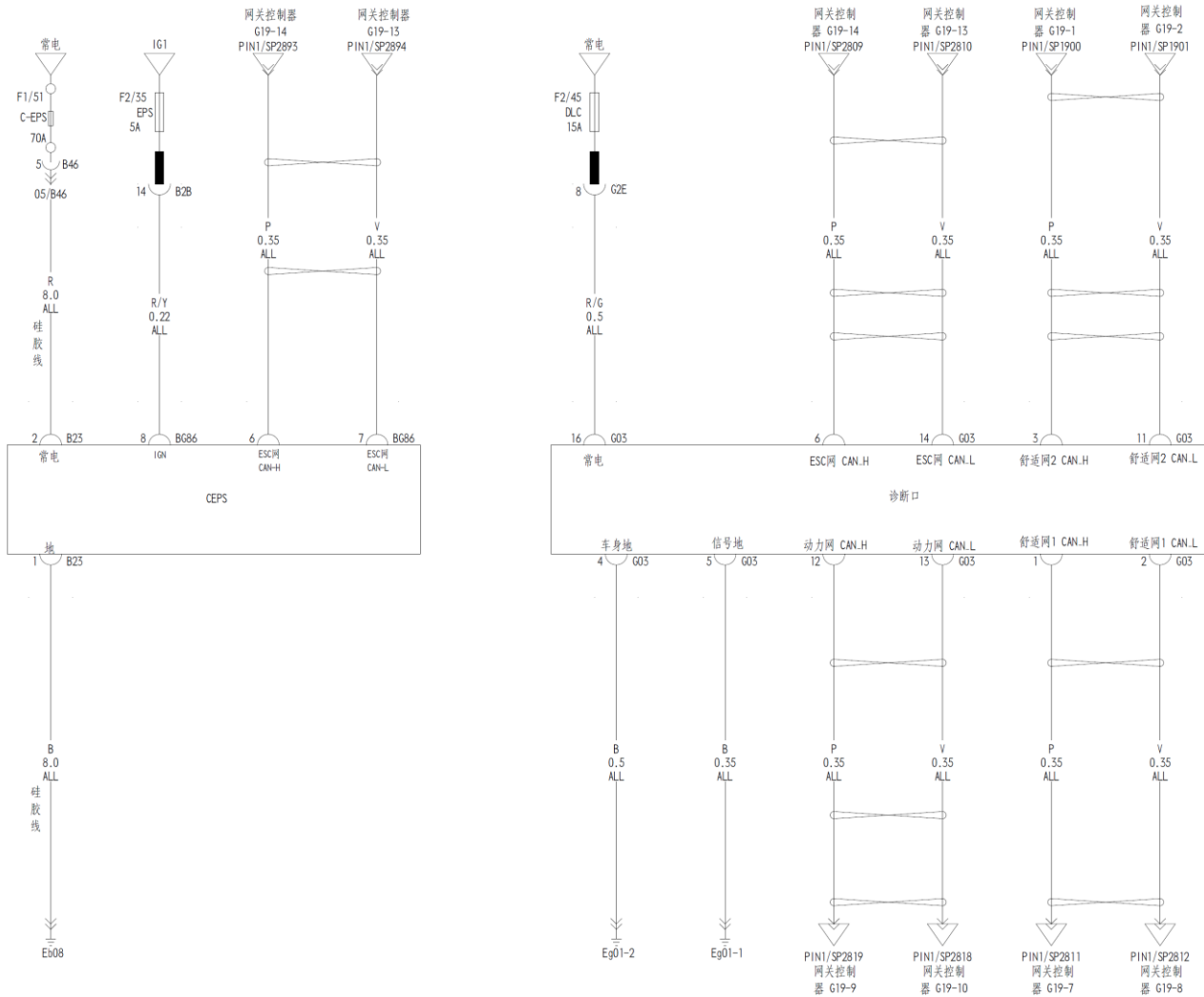

前组合灯（位置灯/转向灯/昼行灯/远近光灯）/灯光开关组

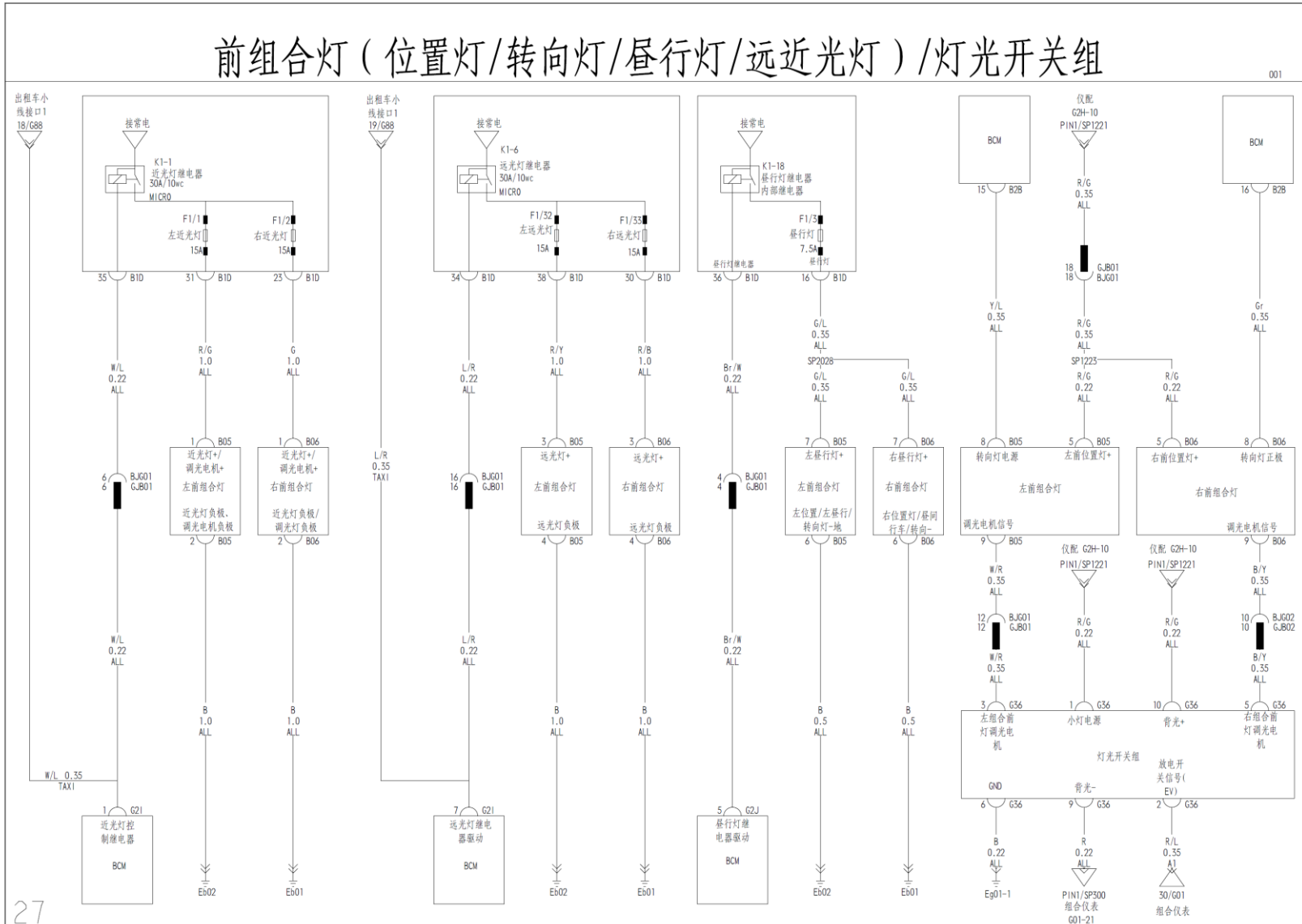

车后灯具 (左转向灯/位置灯/制动灯/后雾灯)

002

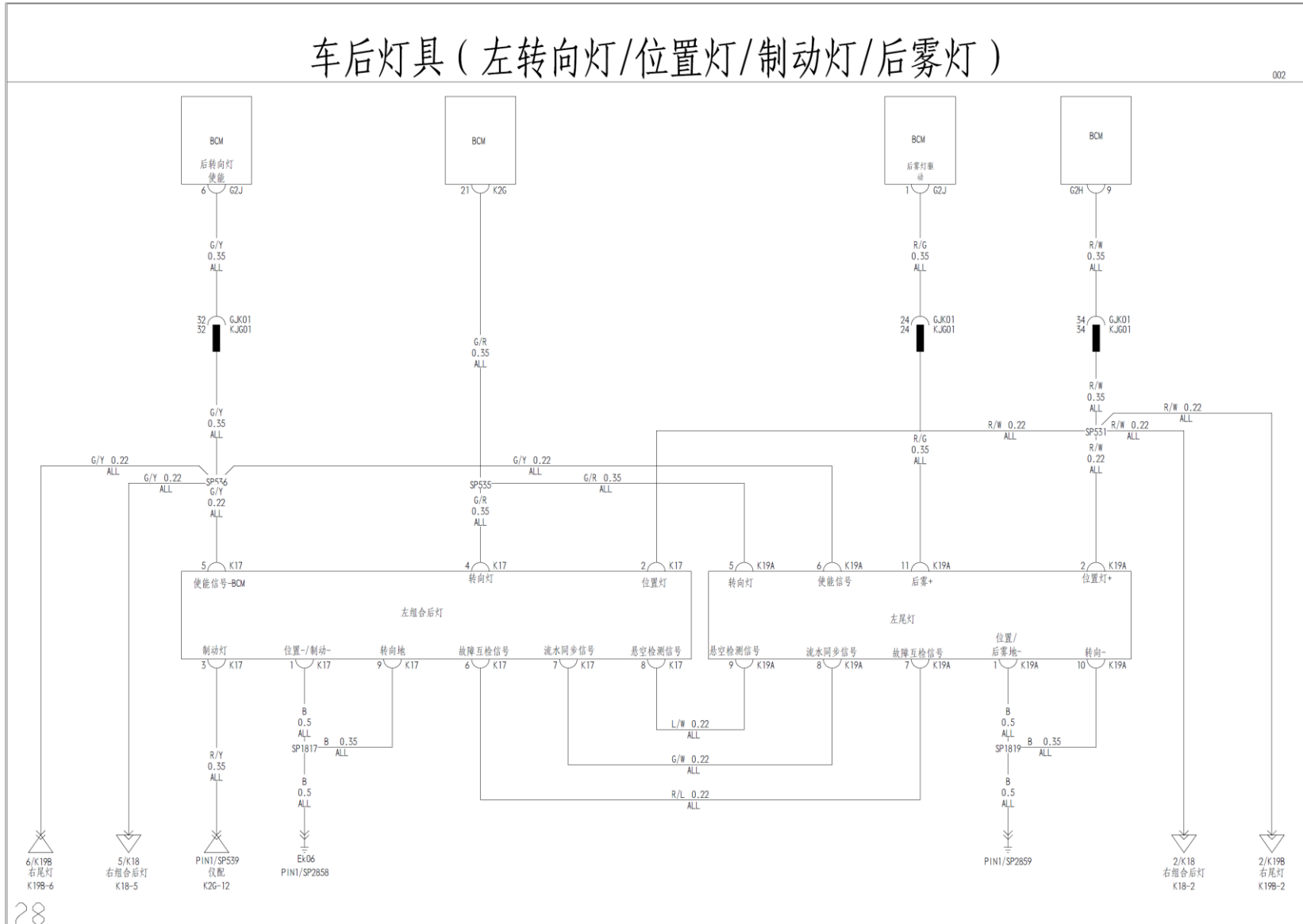



车后灯具 (右转向灯/位置灯/制动灯/倒车灯/高位制动灯)

003

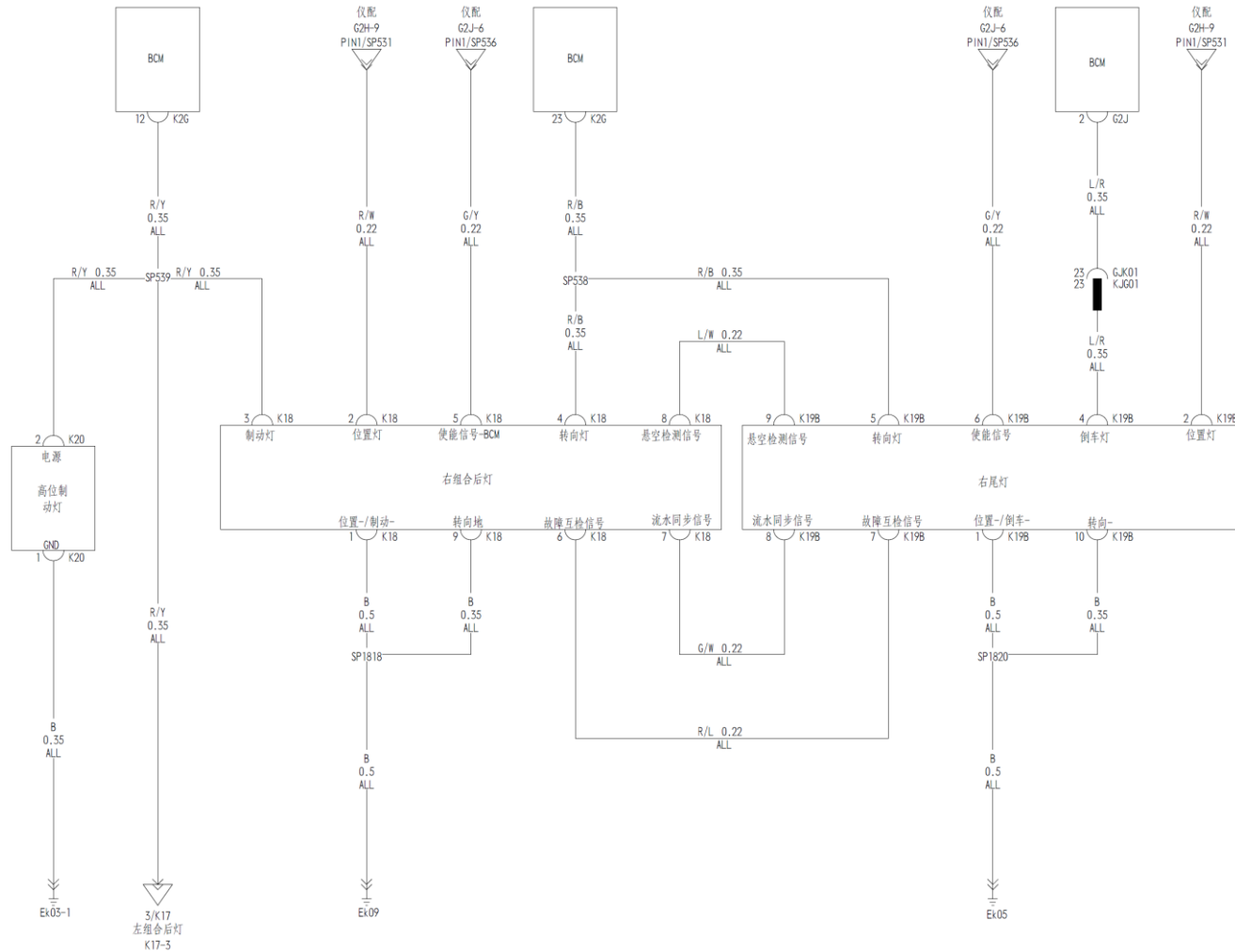



前、后室内灯 (PAD主机)

001

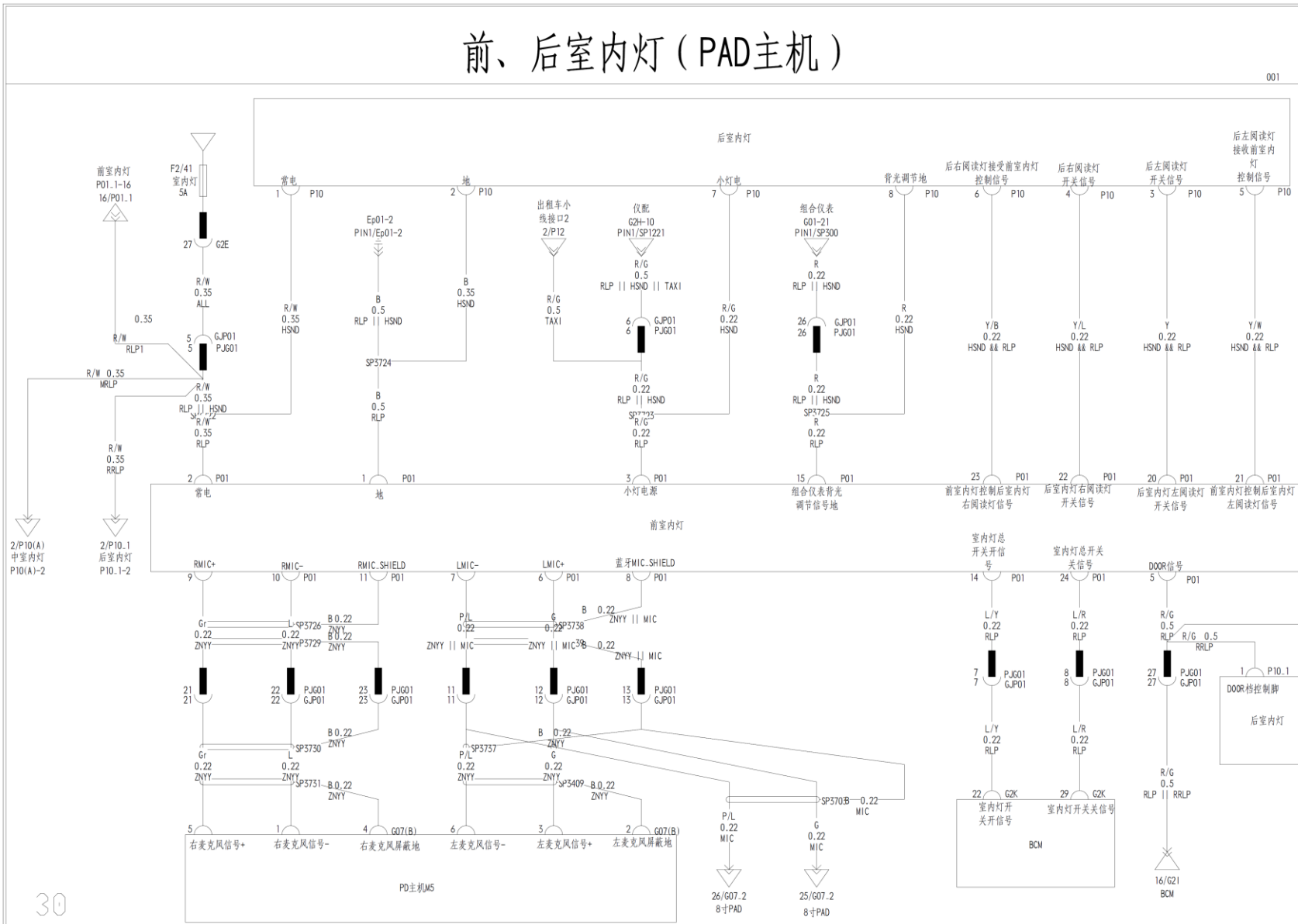

30

前/天窗电机

002

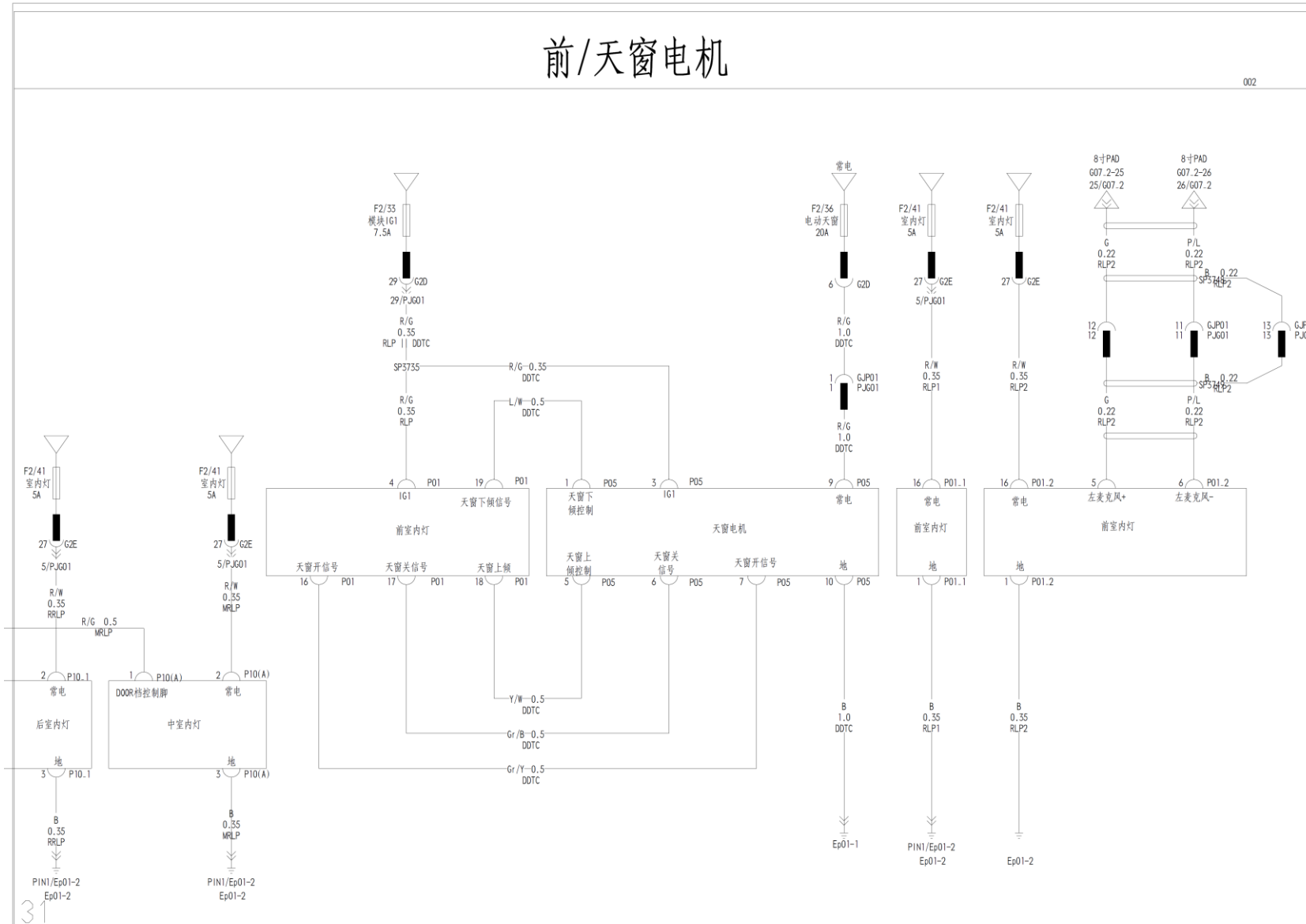

31

小灯/背光系统

001

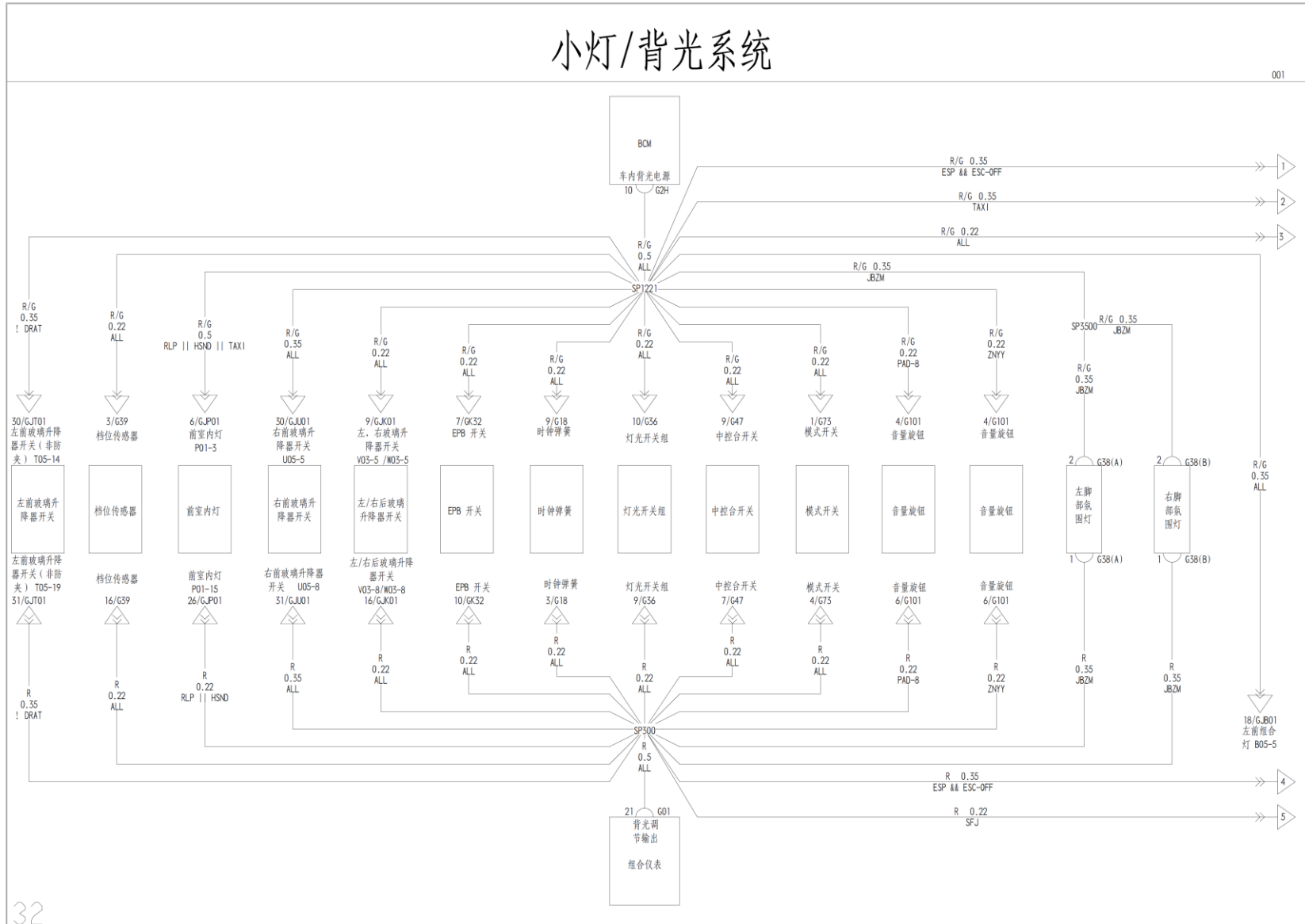

32

小灯/背光系统

002

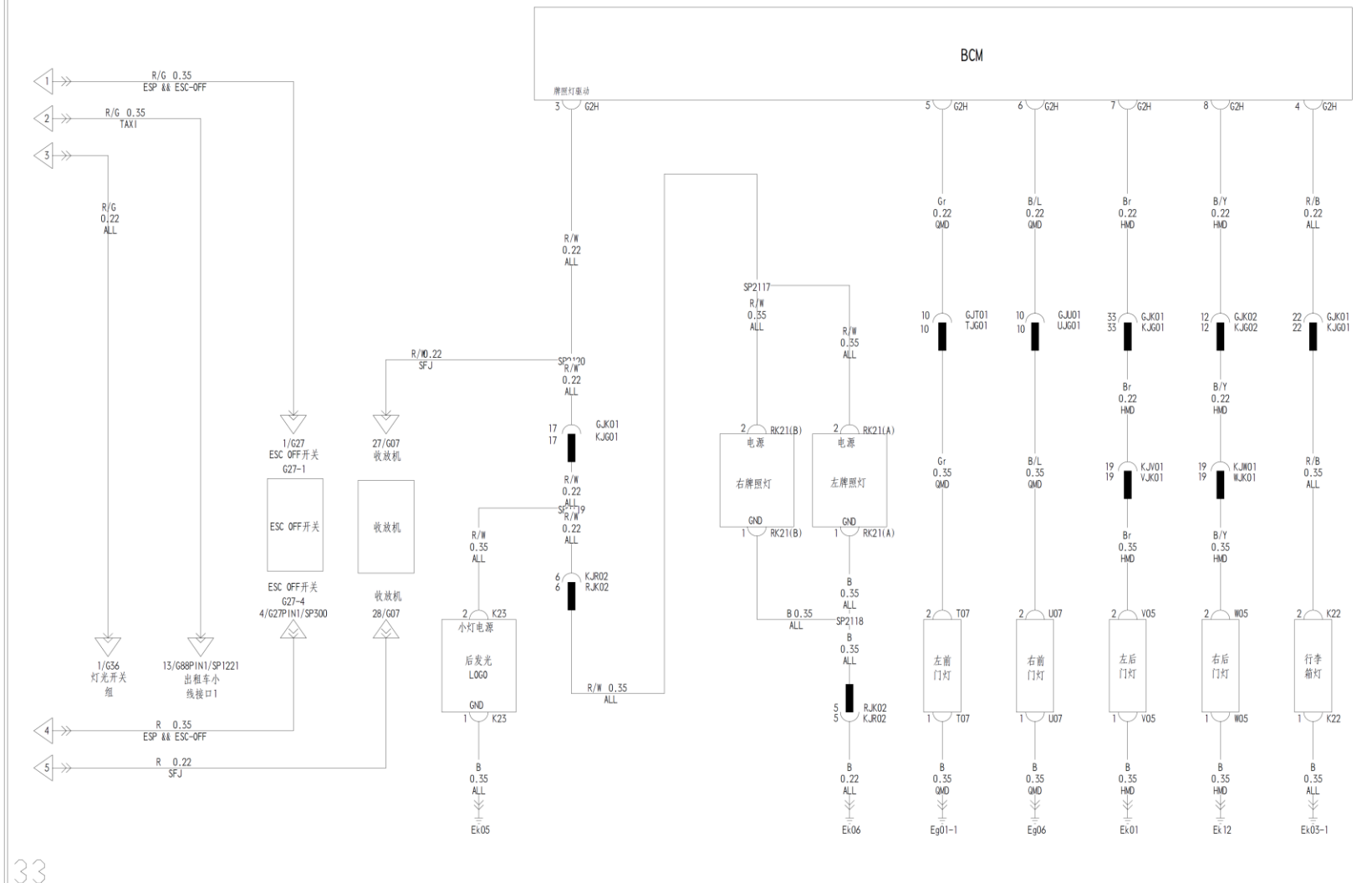

33



左外后视镜(NFC)

001

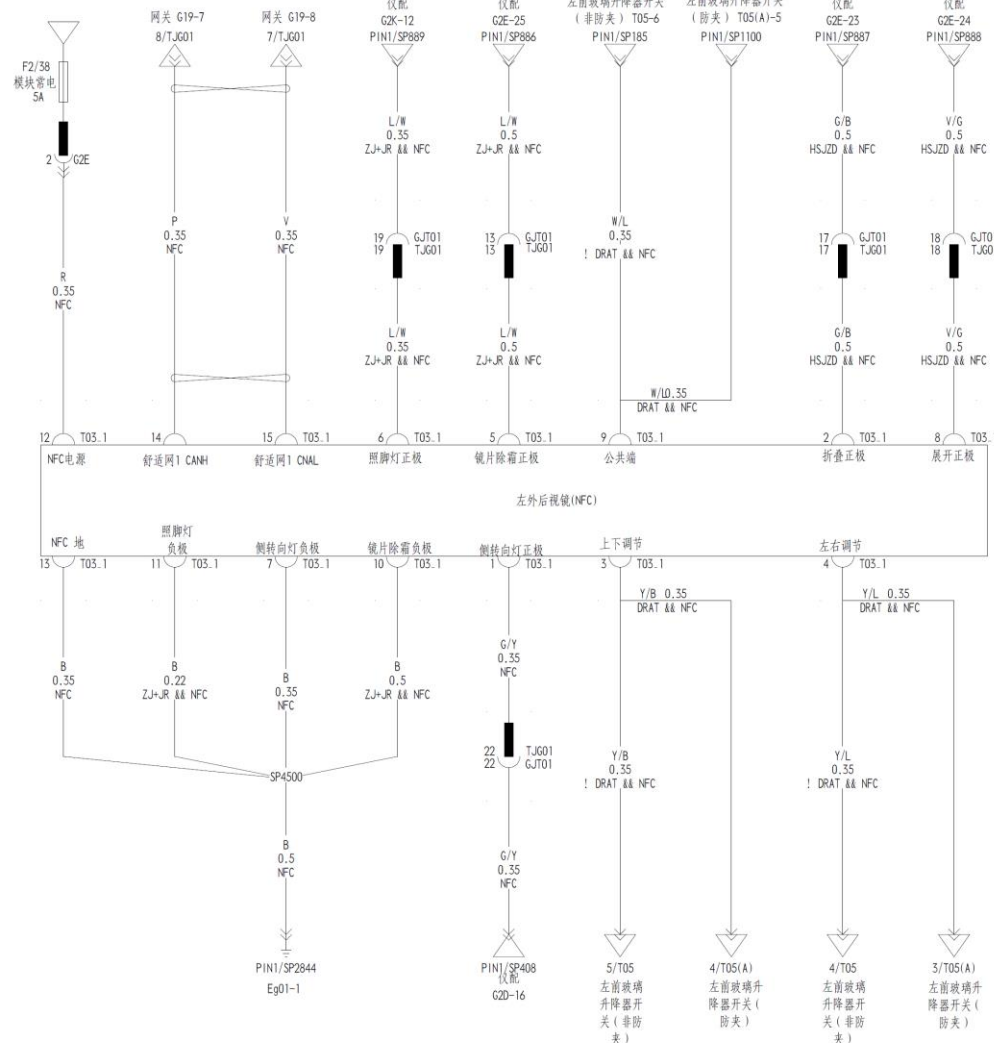



左、右外后视镜

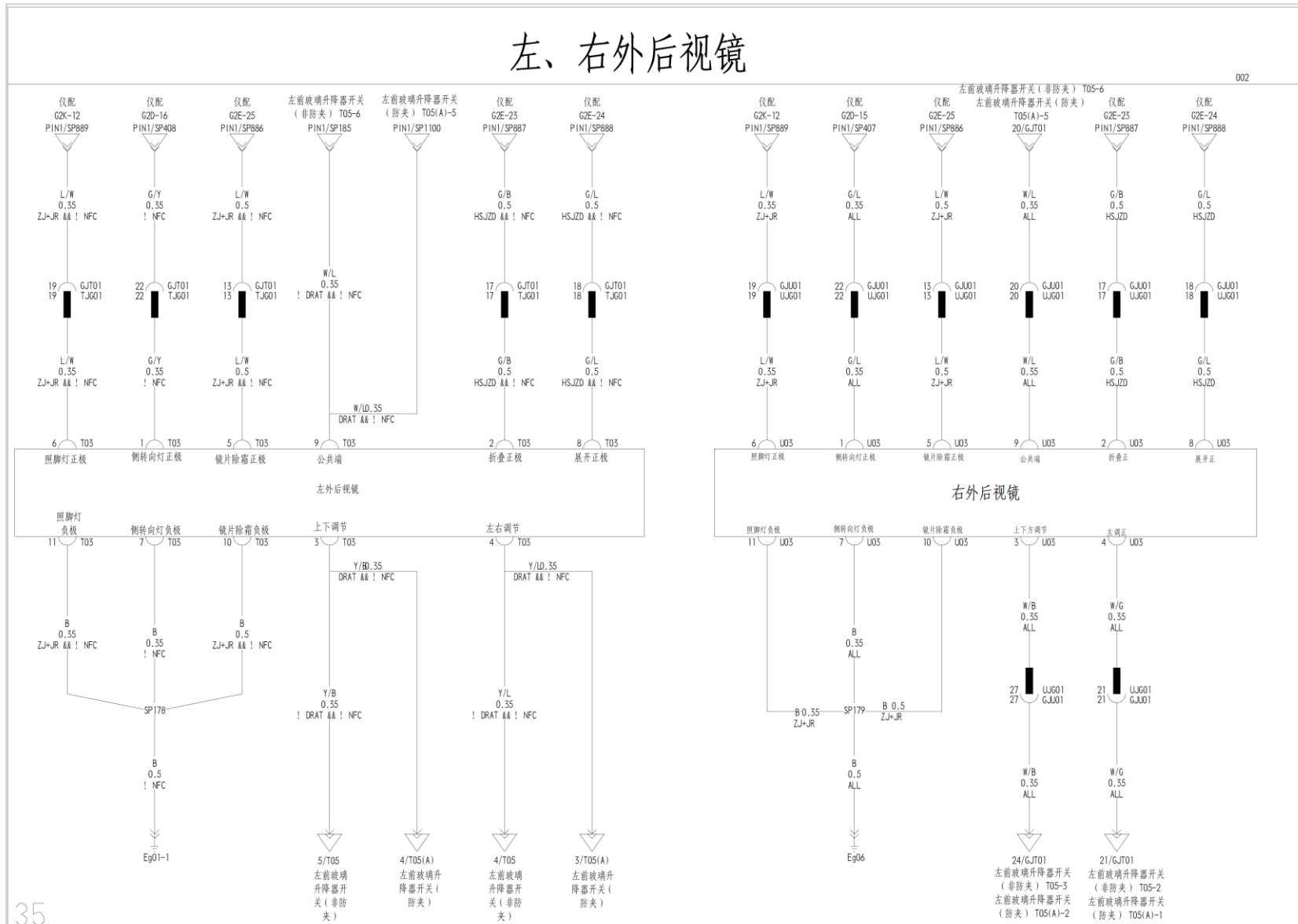



左前玻璃升降器开关(防夹)

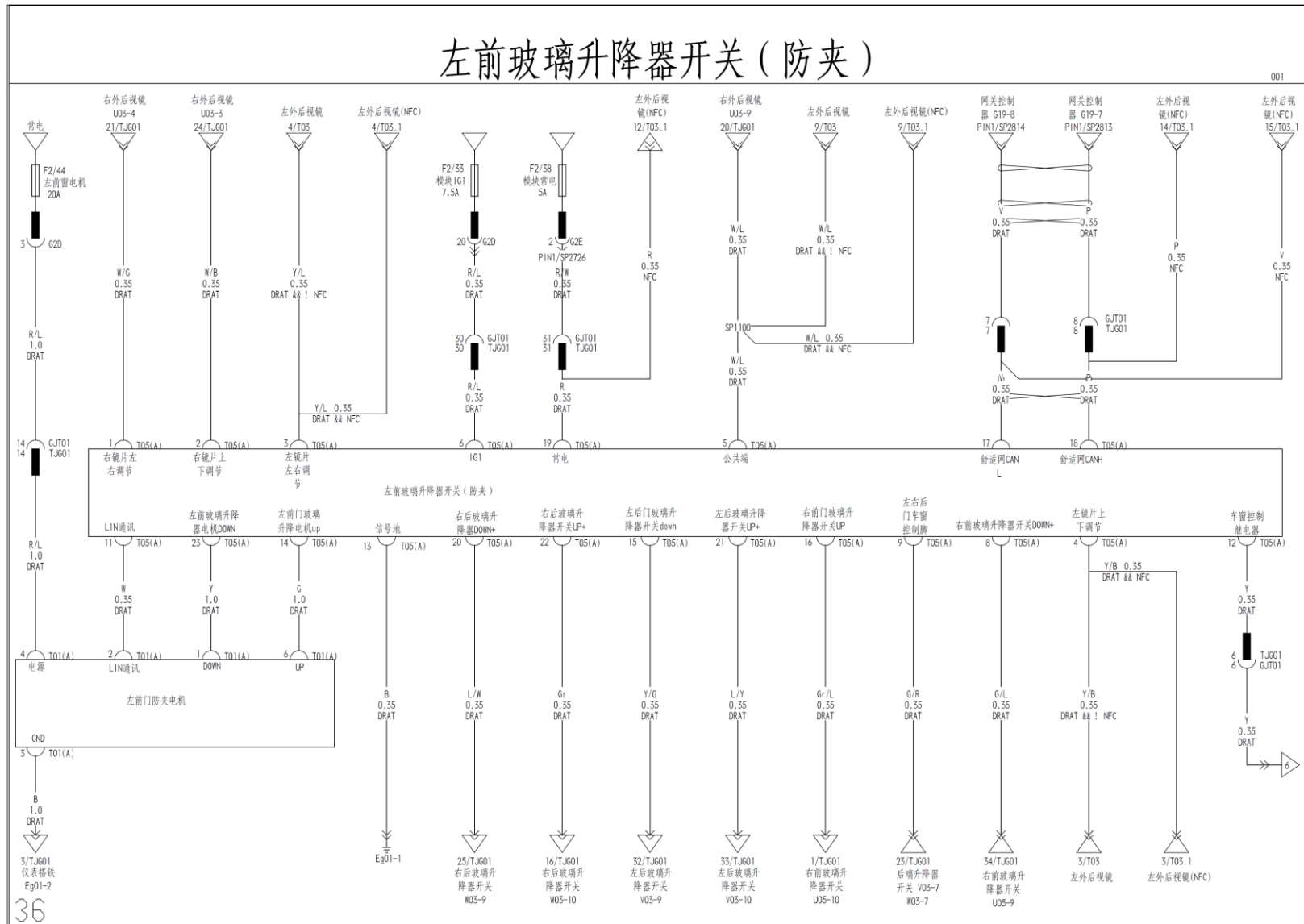



左前玻璃升降器开关（非防夹）

002

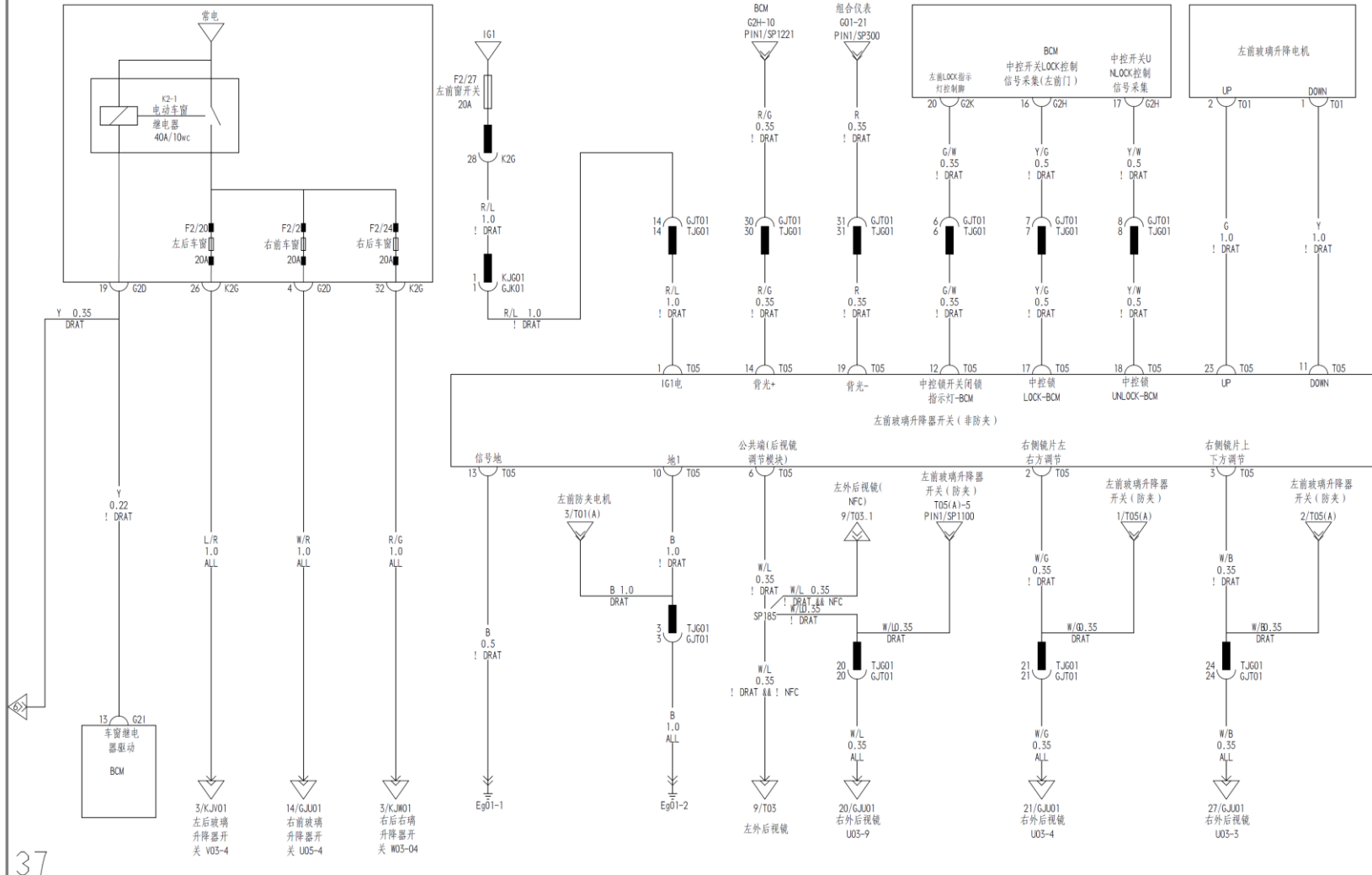

37



左、右前玻璃升降器开关（非防夹）

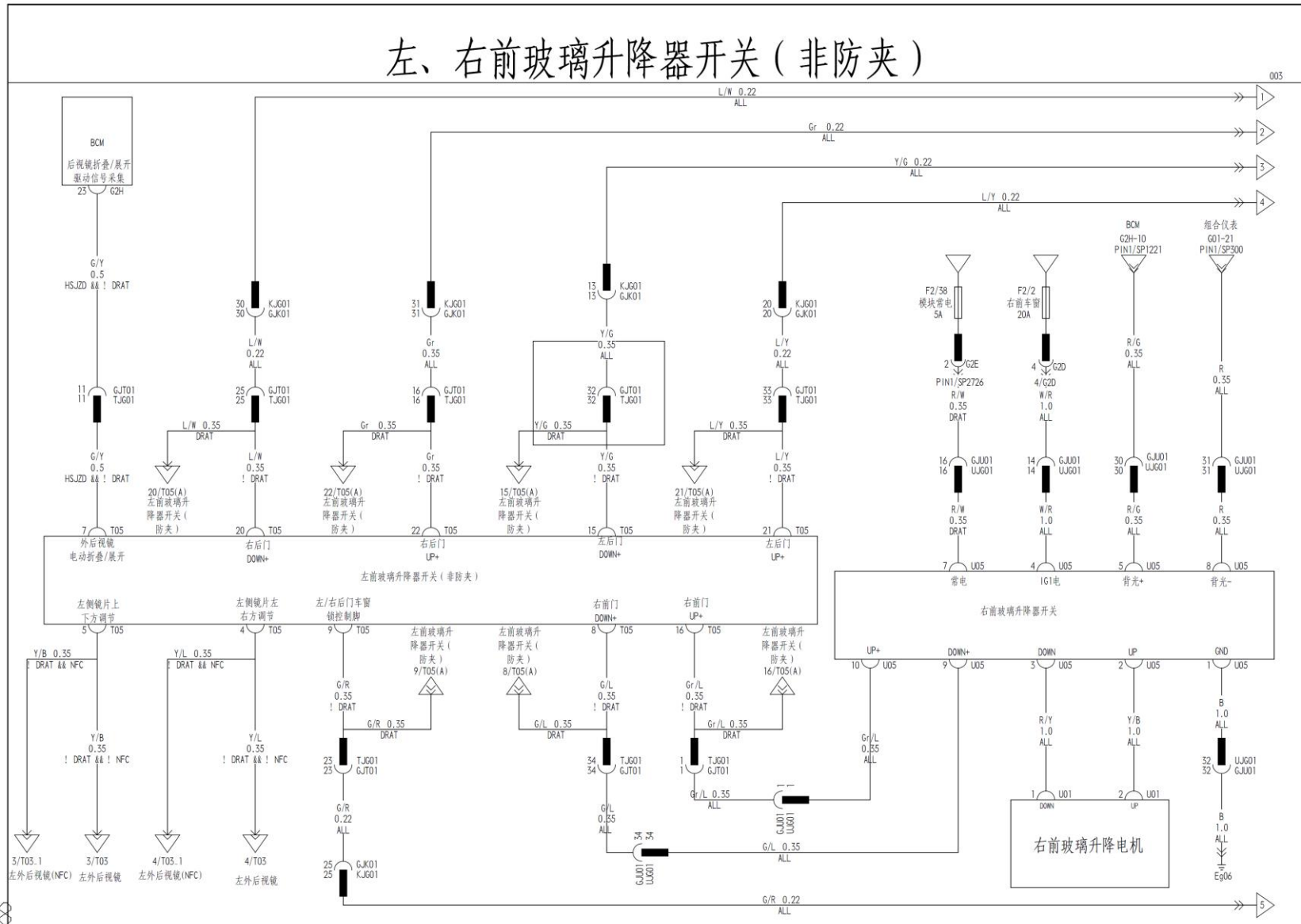

左、右后玻璃升降器开关

004

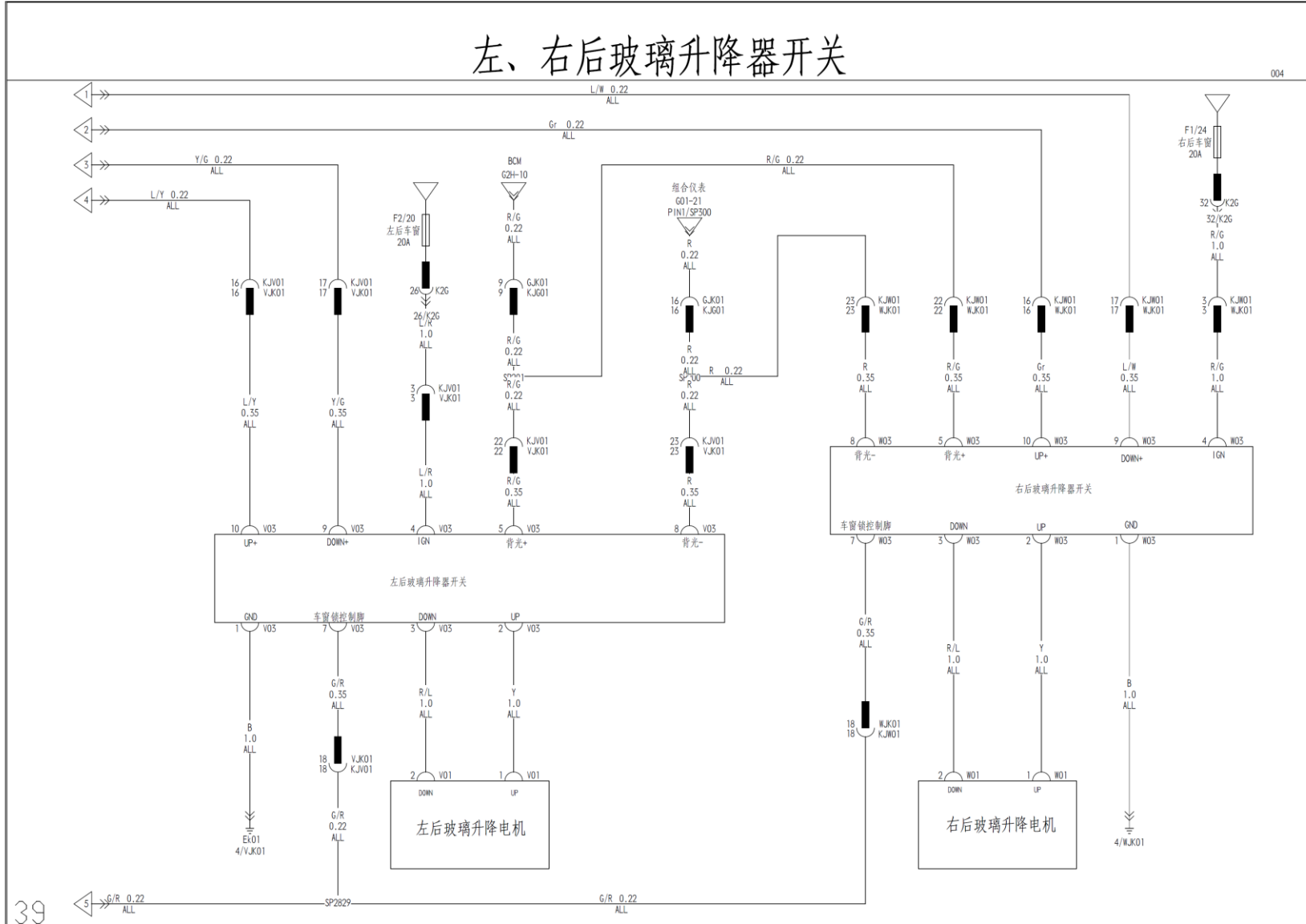

组合/模式/中控开关组

001

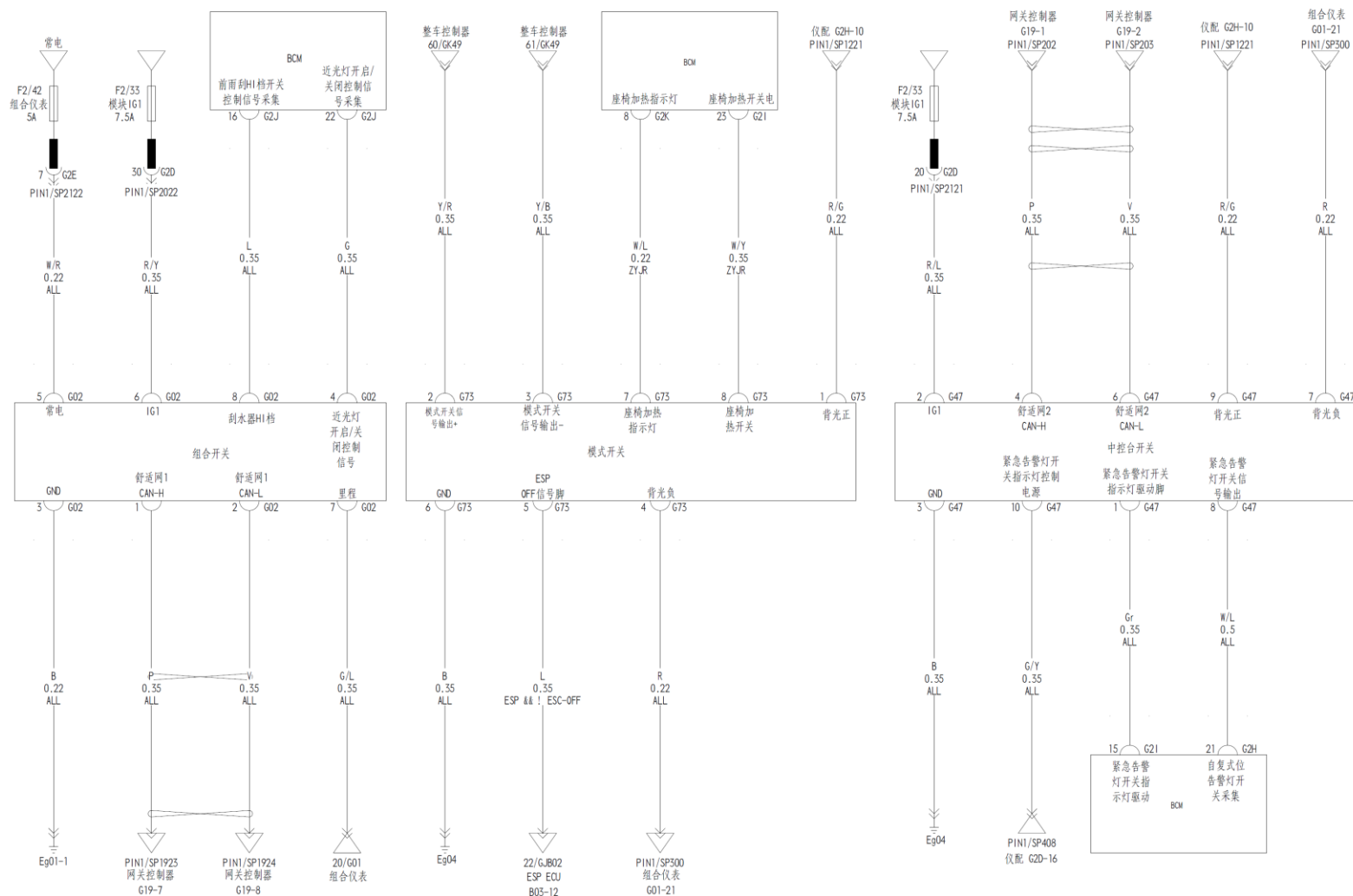



燃油加热器/PTC(风加热器)

001

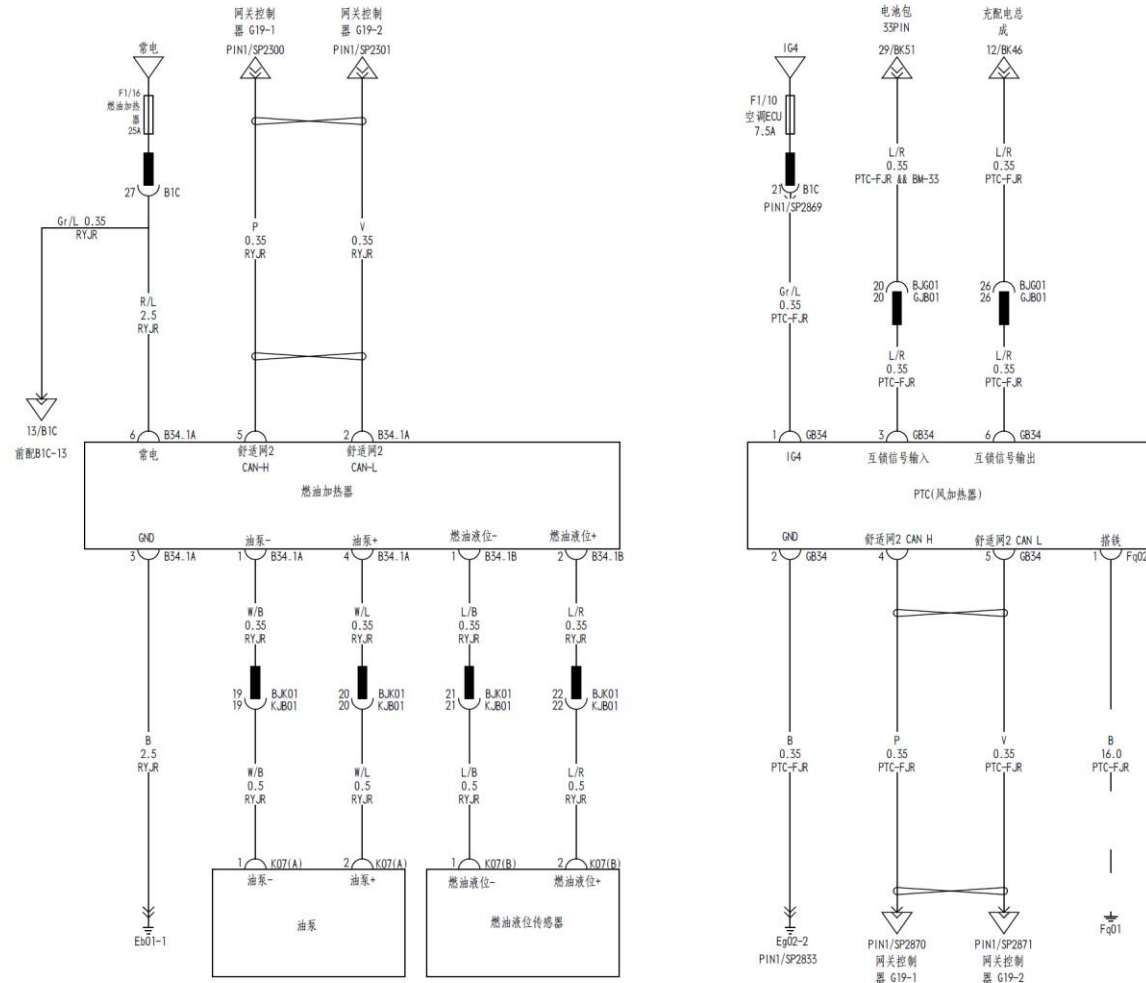



PTC水加热器/电动压缩机/电池加热器

002

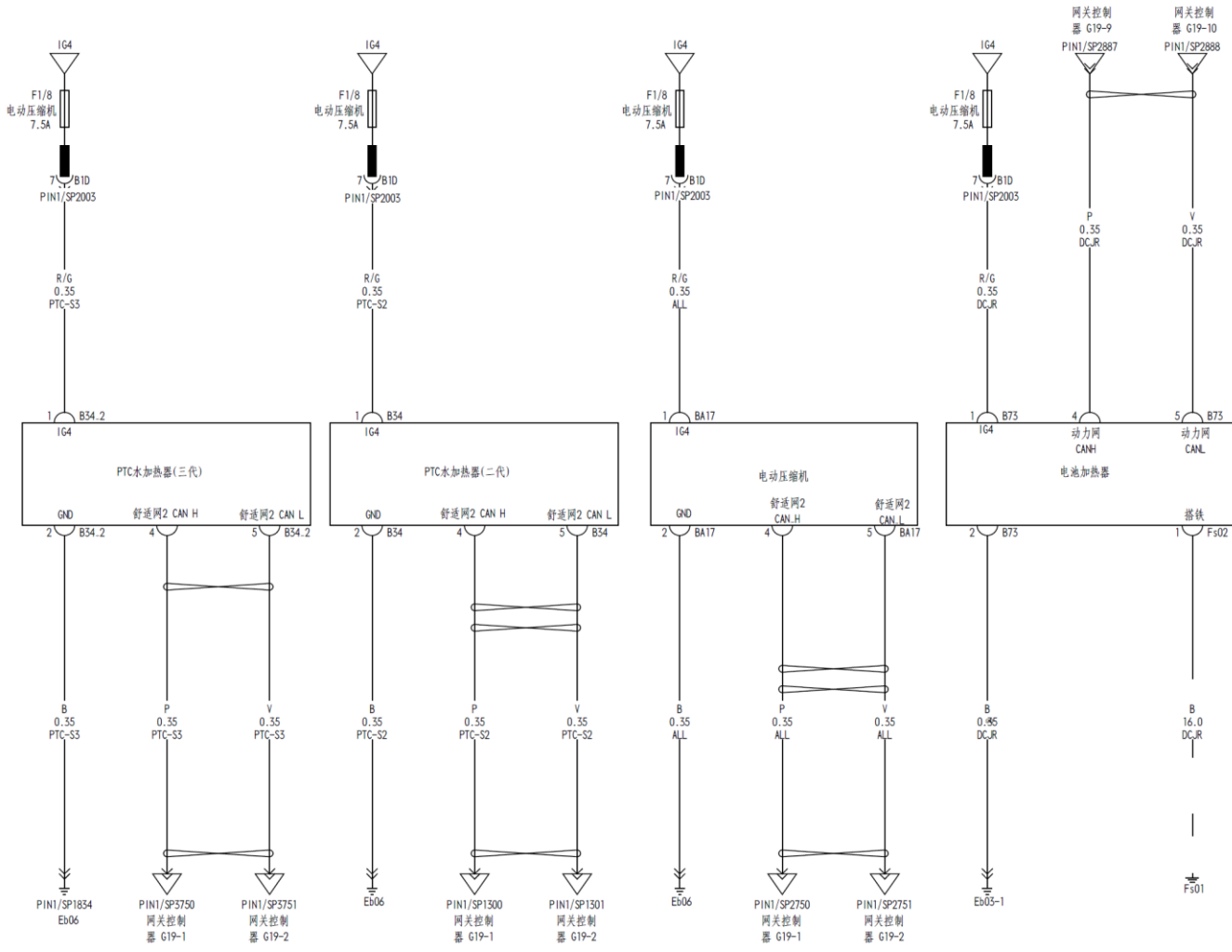



空调控制器

005

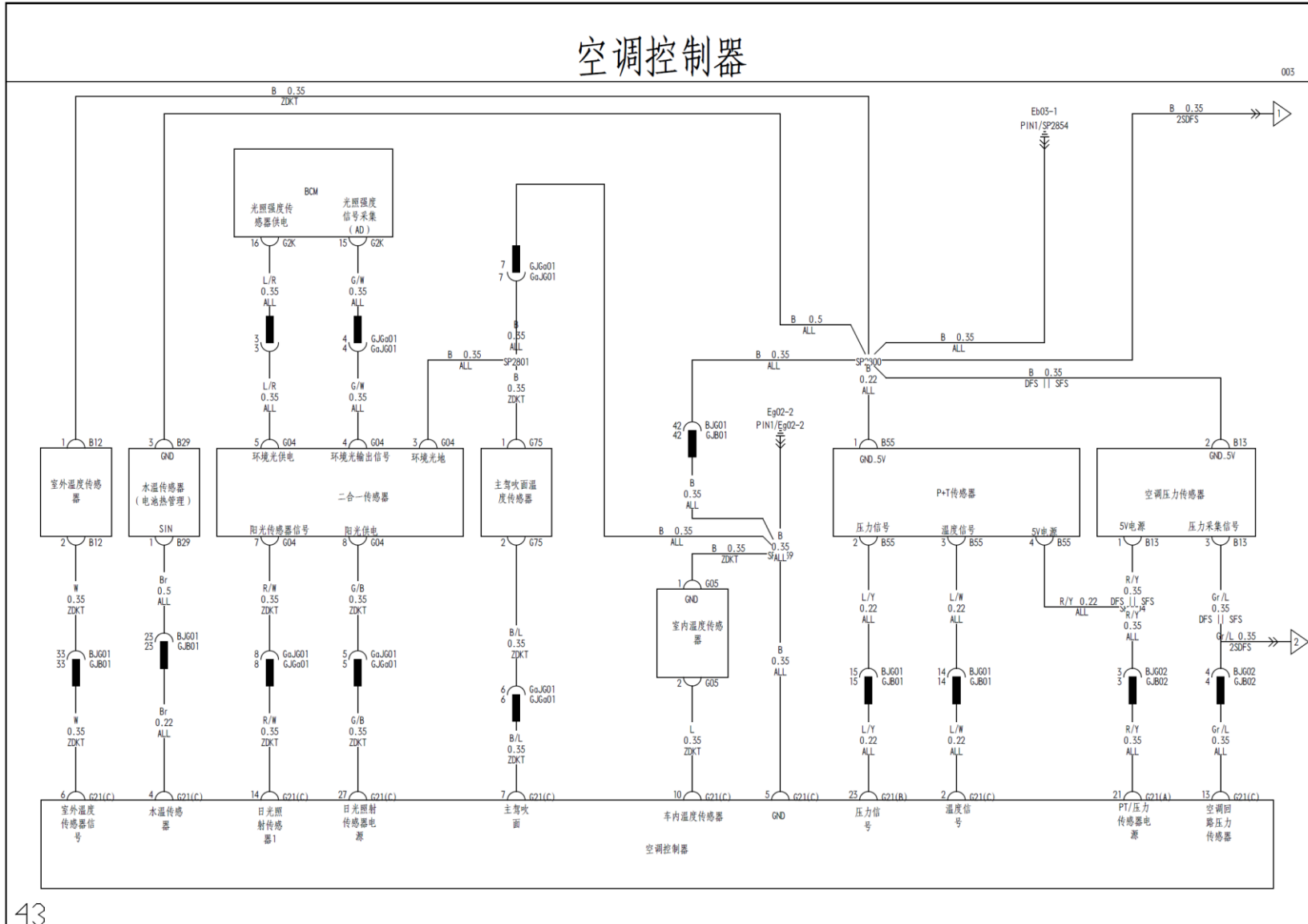

43

空调控制器

004

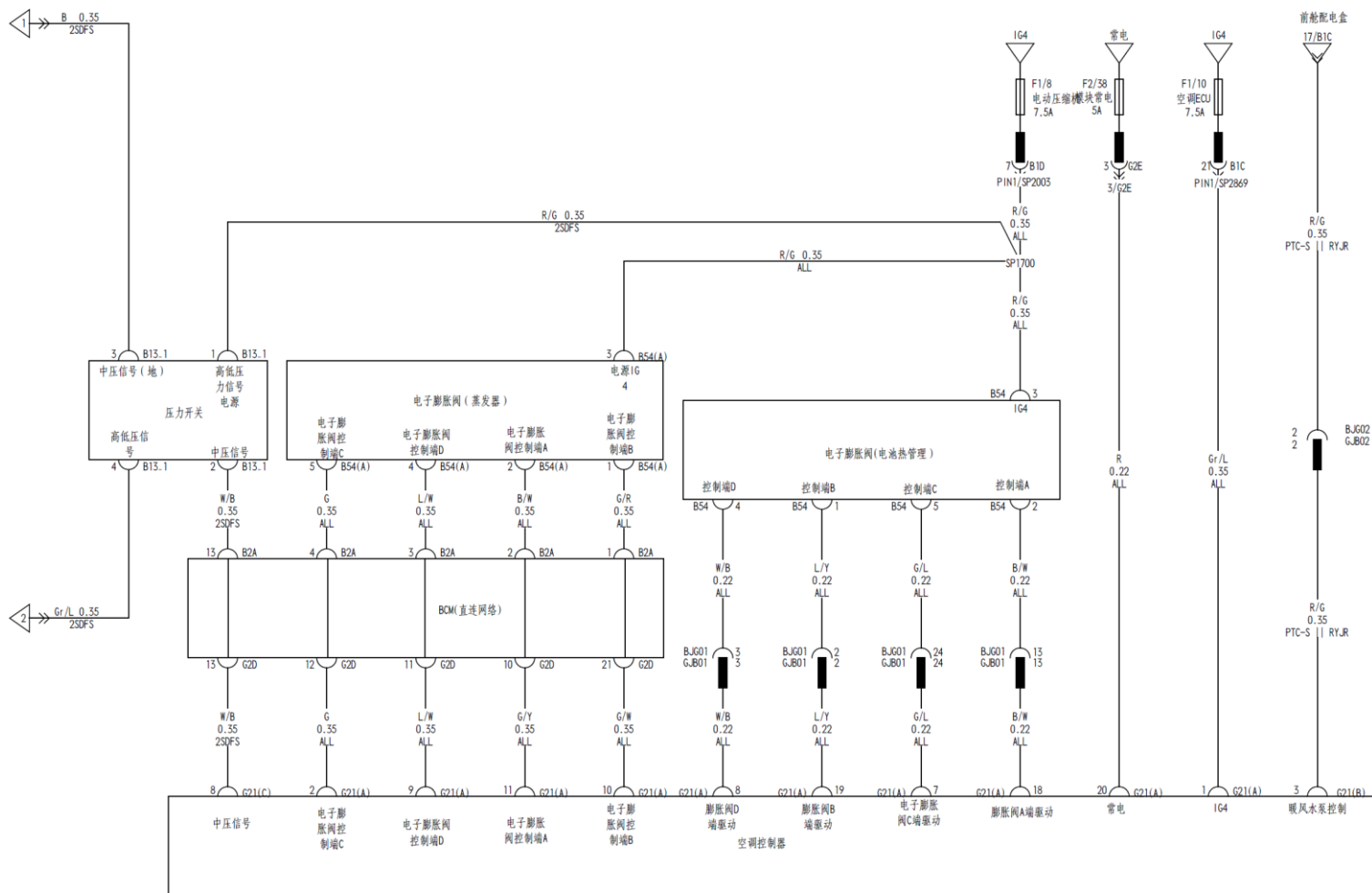

空调控制器 (空调小线)

005

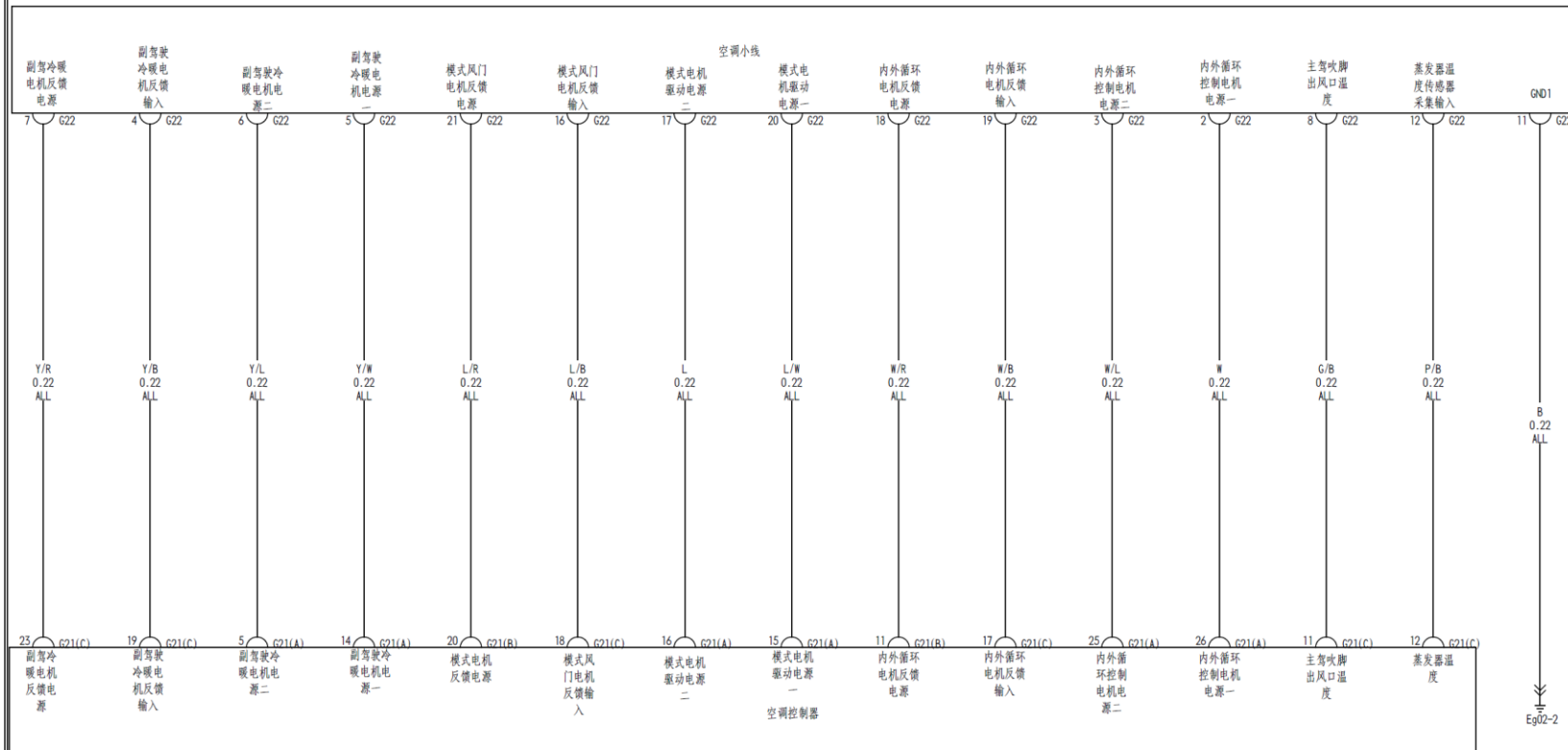

空调控制器 (四通水阀、鼓风机、电动水泵)

006

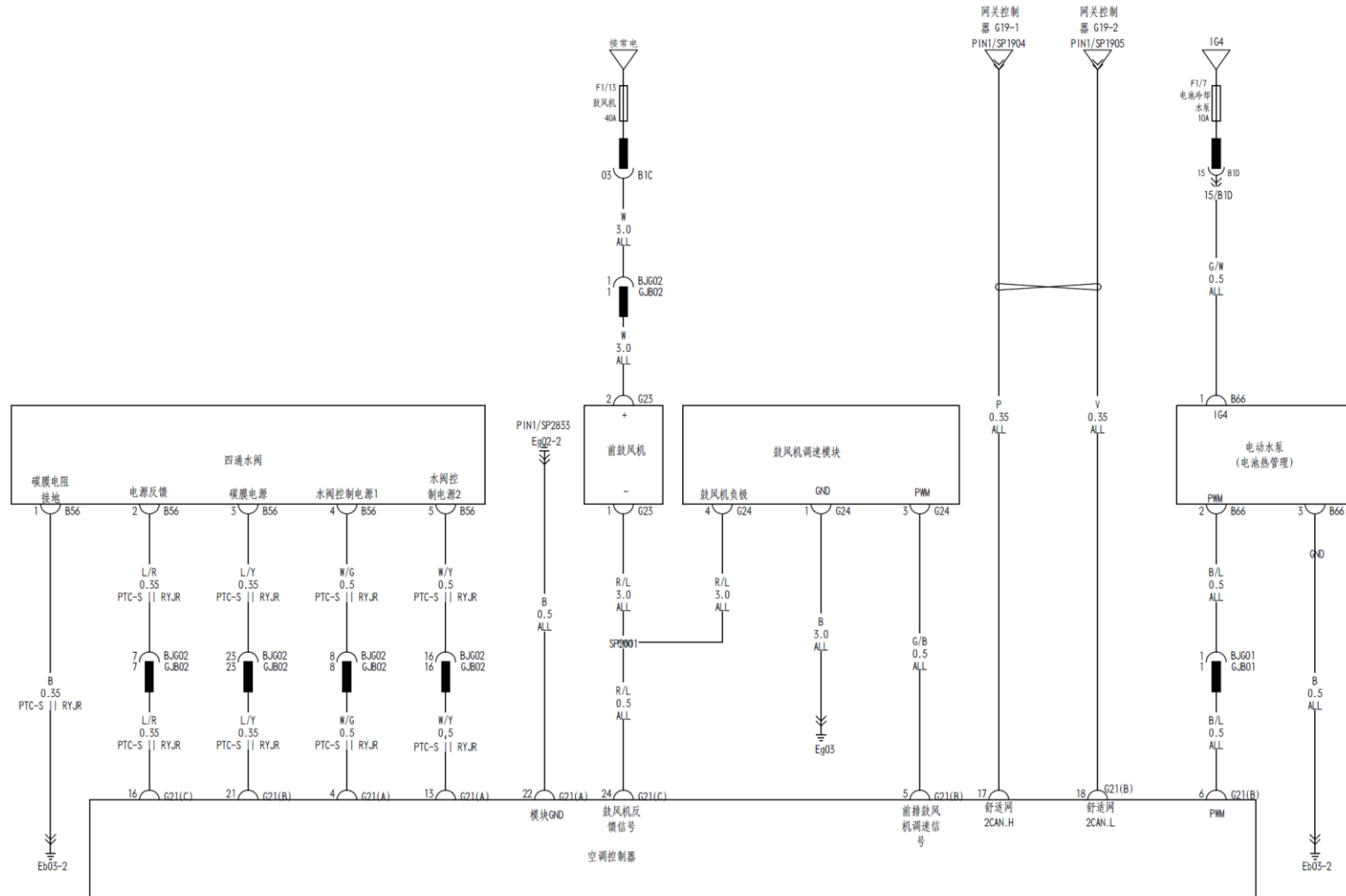



充配电总成/交流充电口

001

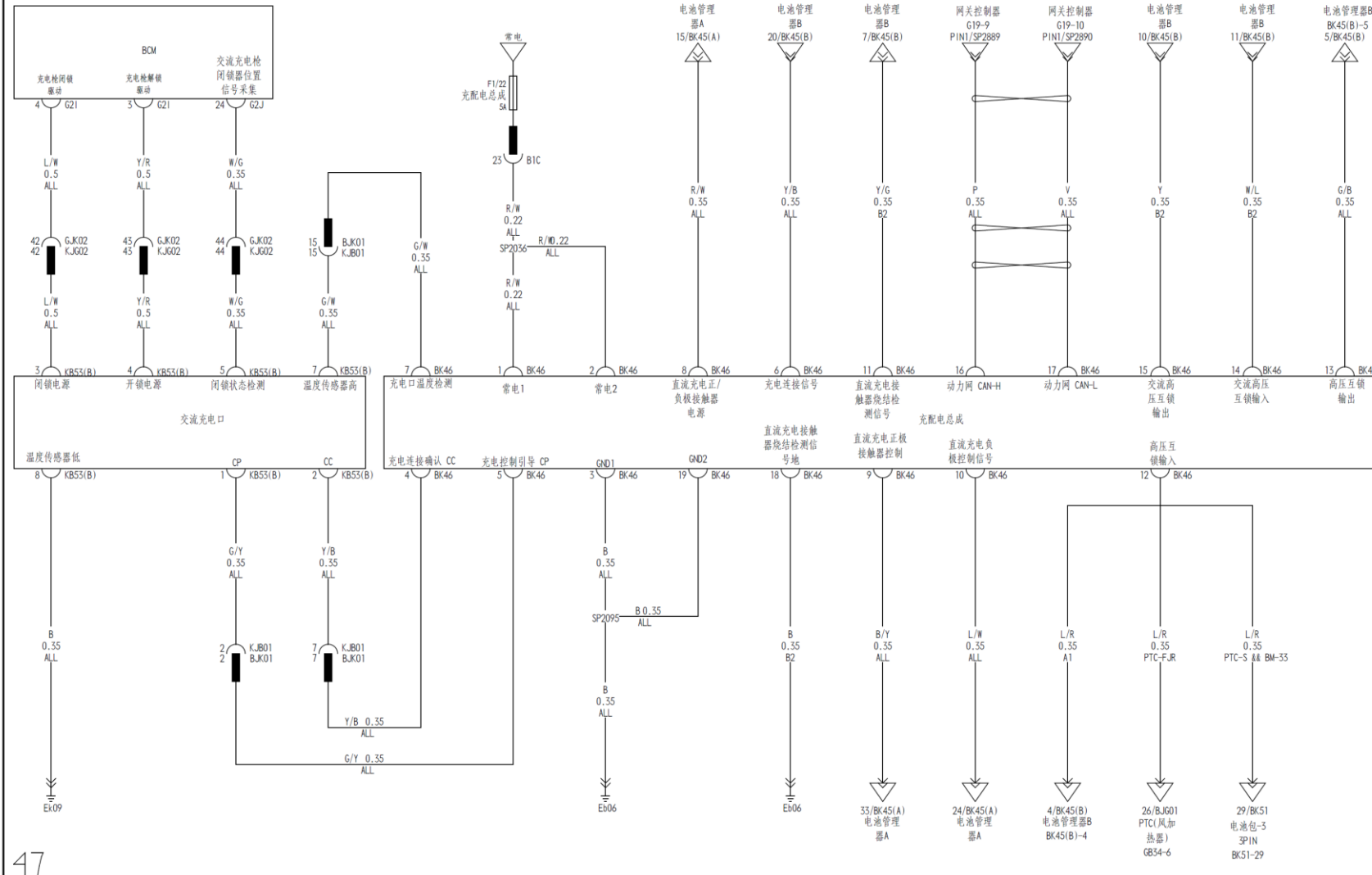

驱动电机控制器/档位传感器

002

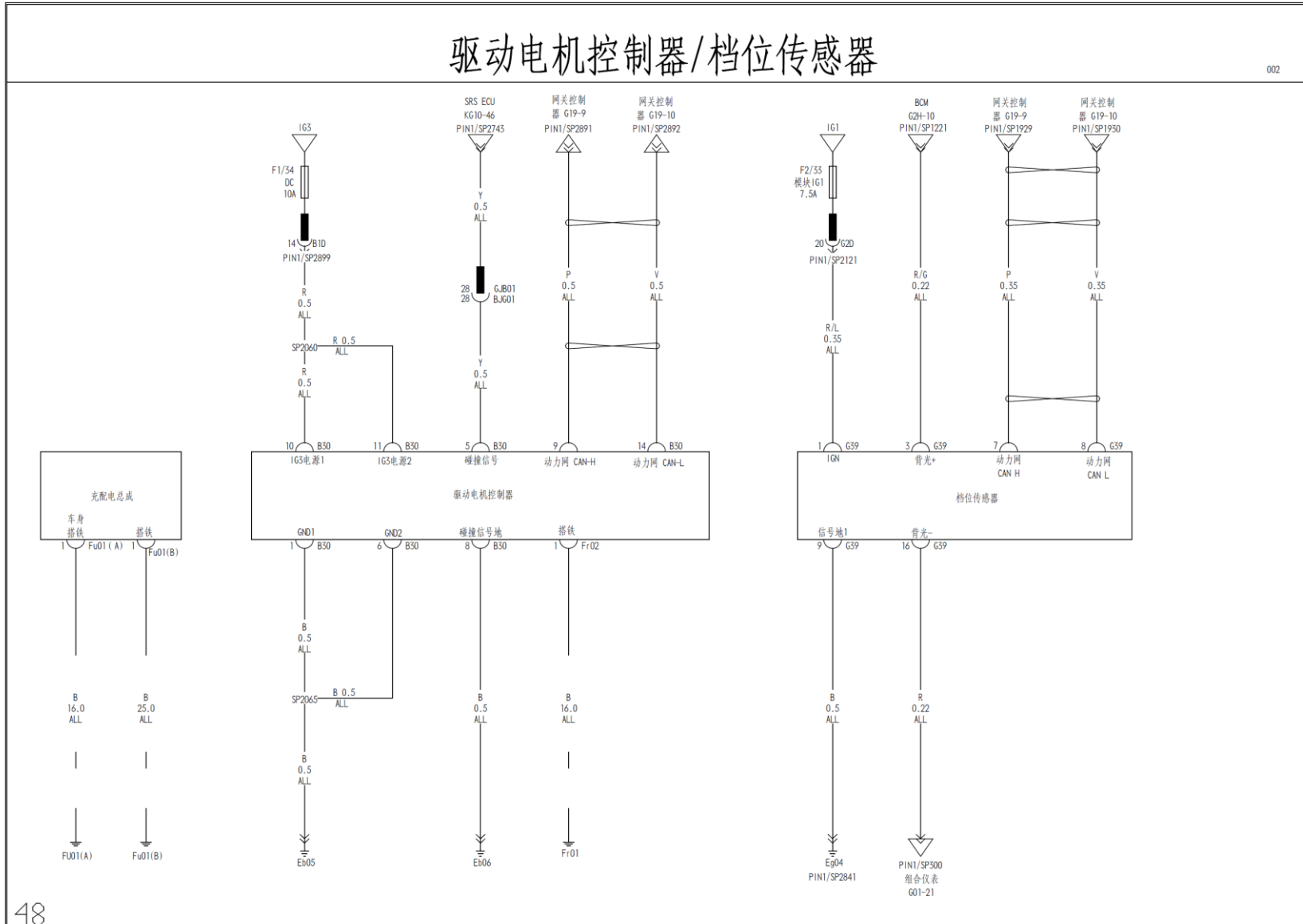



整车控制器 (油门深度传感器/真空压力传感器)

003

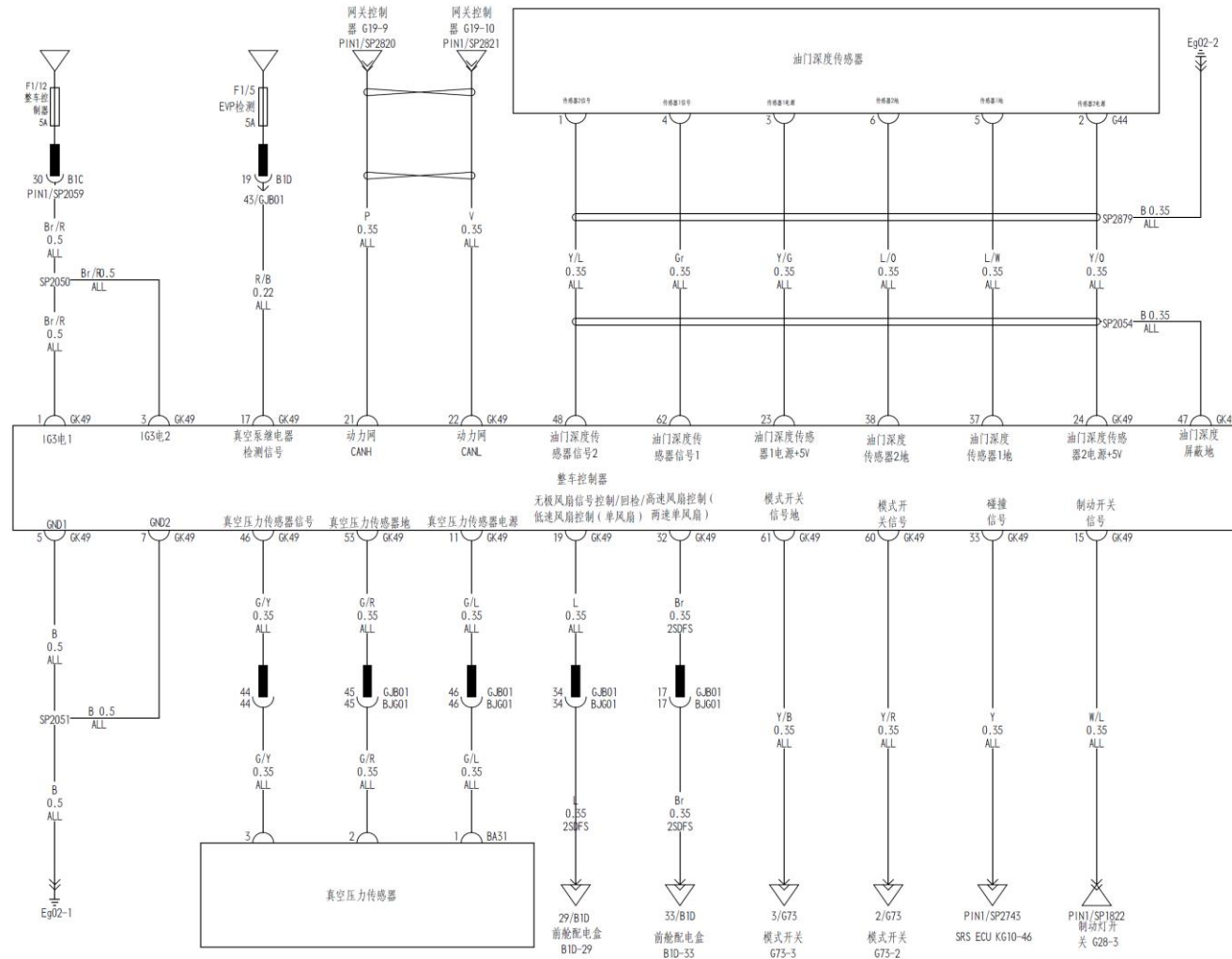

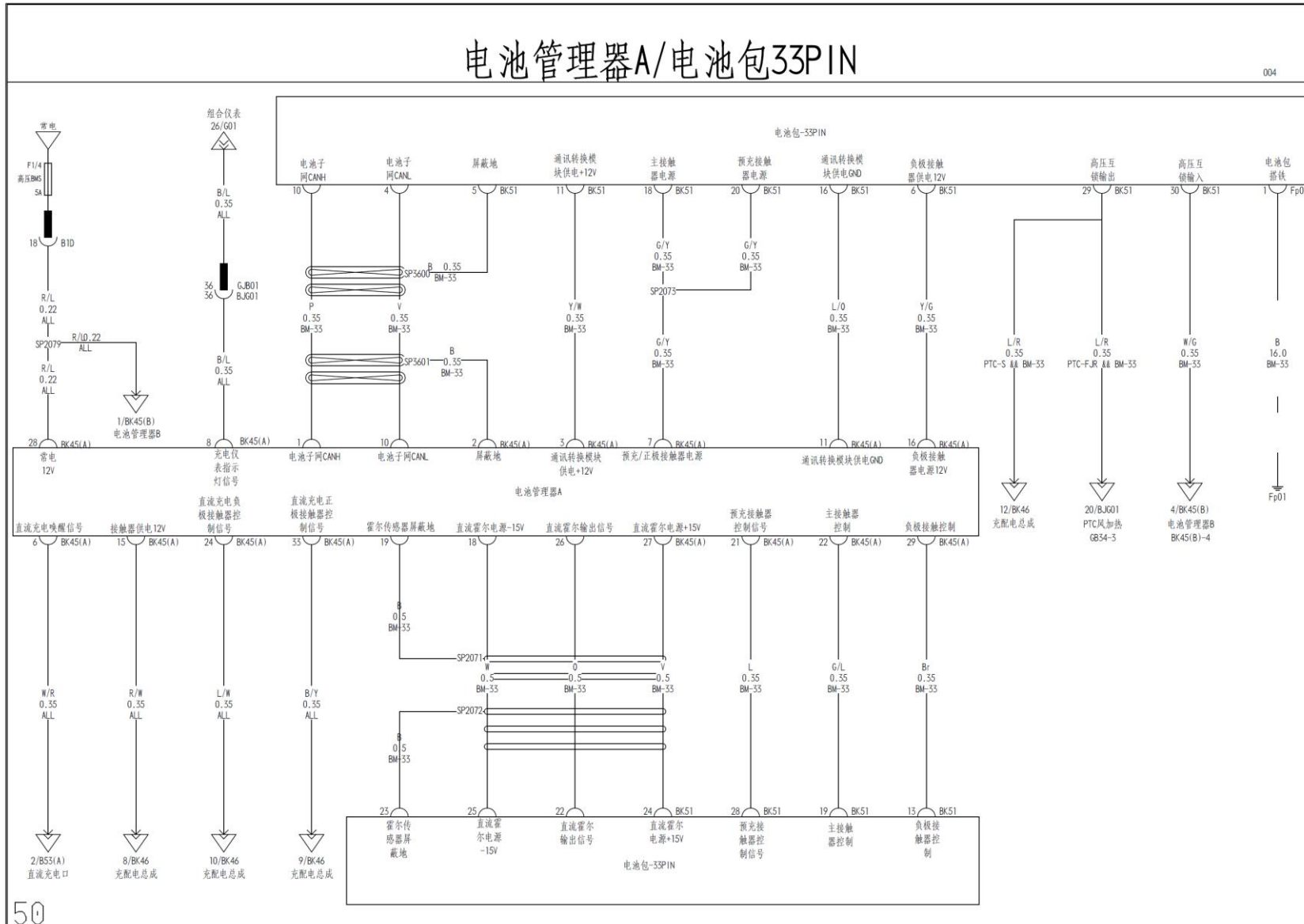



电池管理器B/直流充电口

005

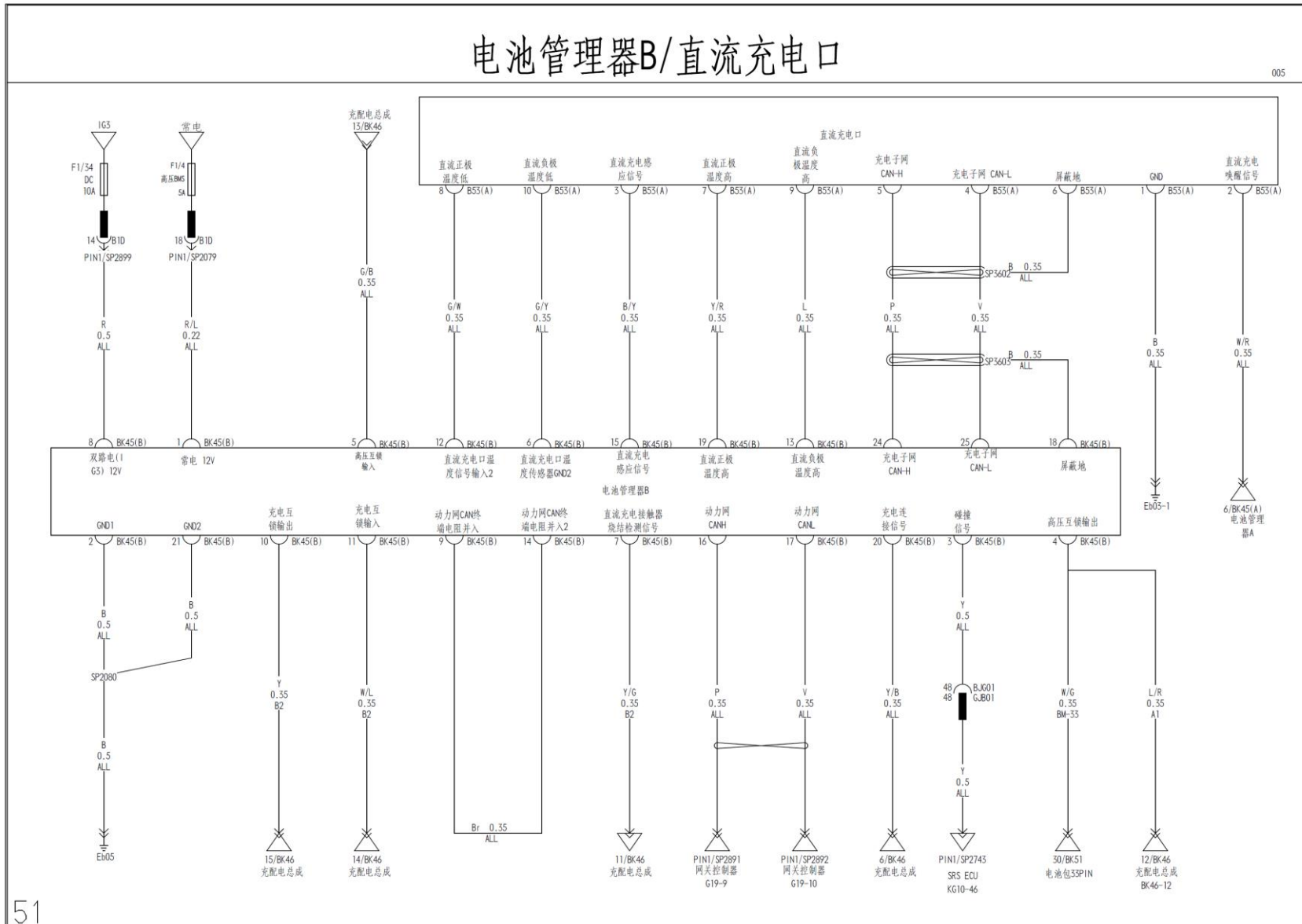

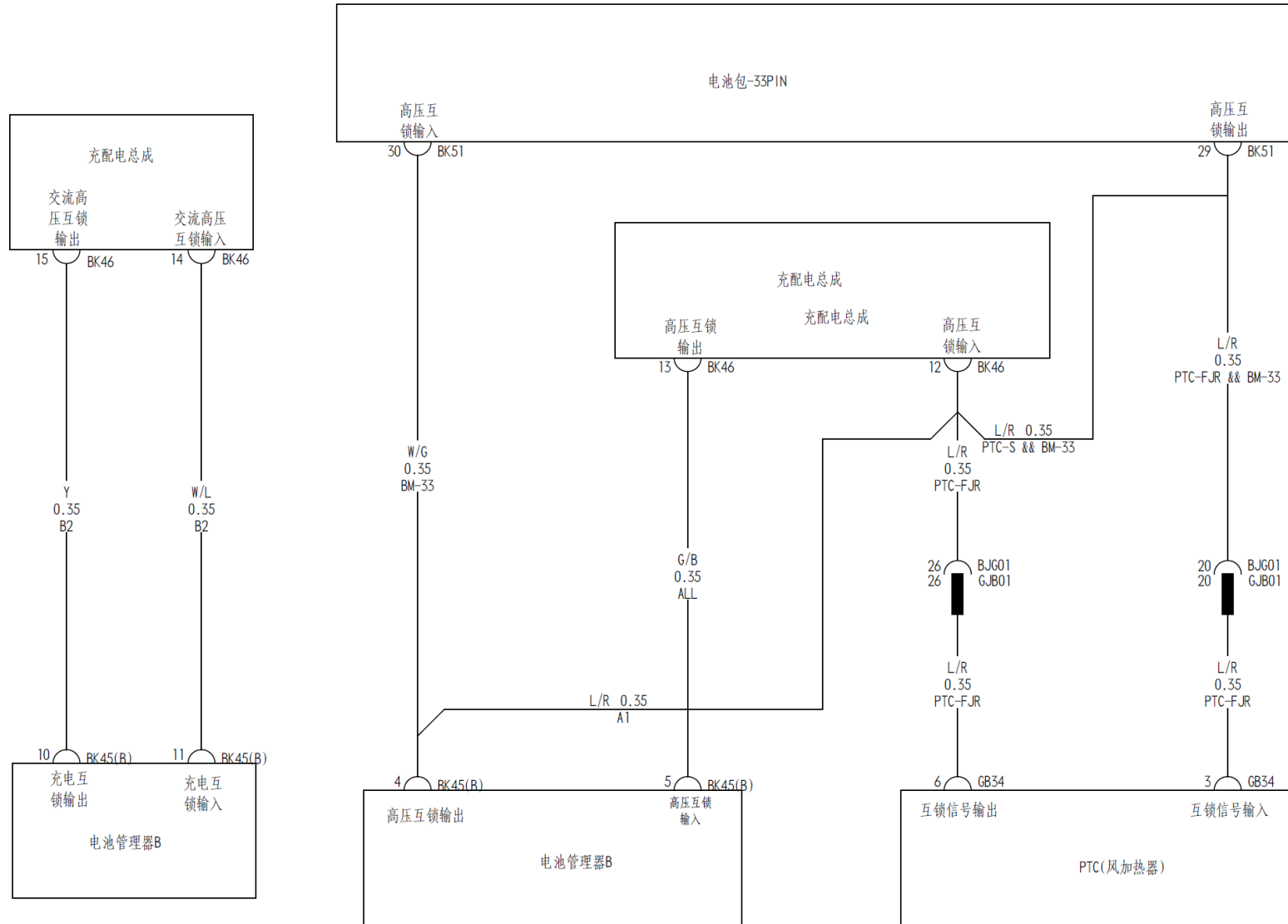

舒适网1 (网关控制器、舒适网2)

001

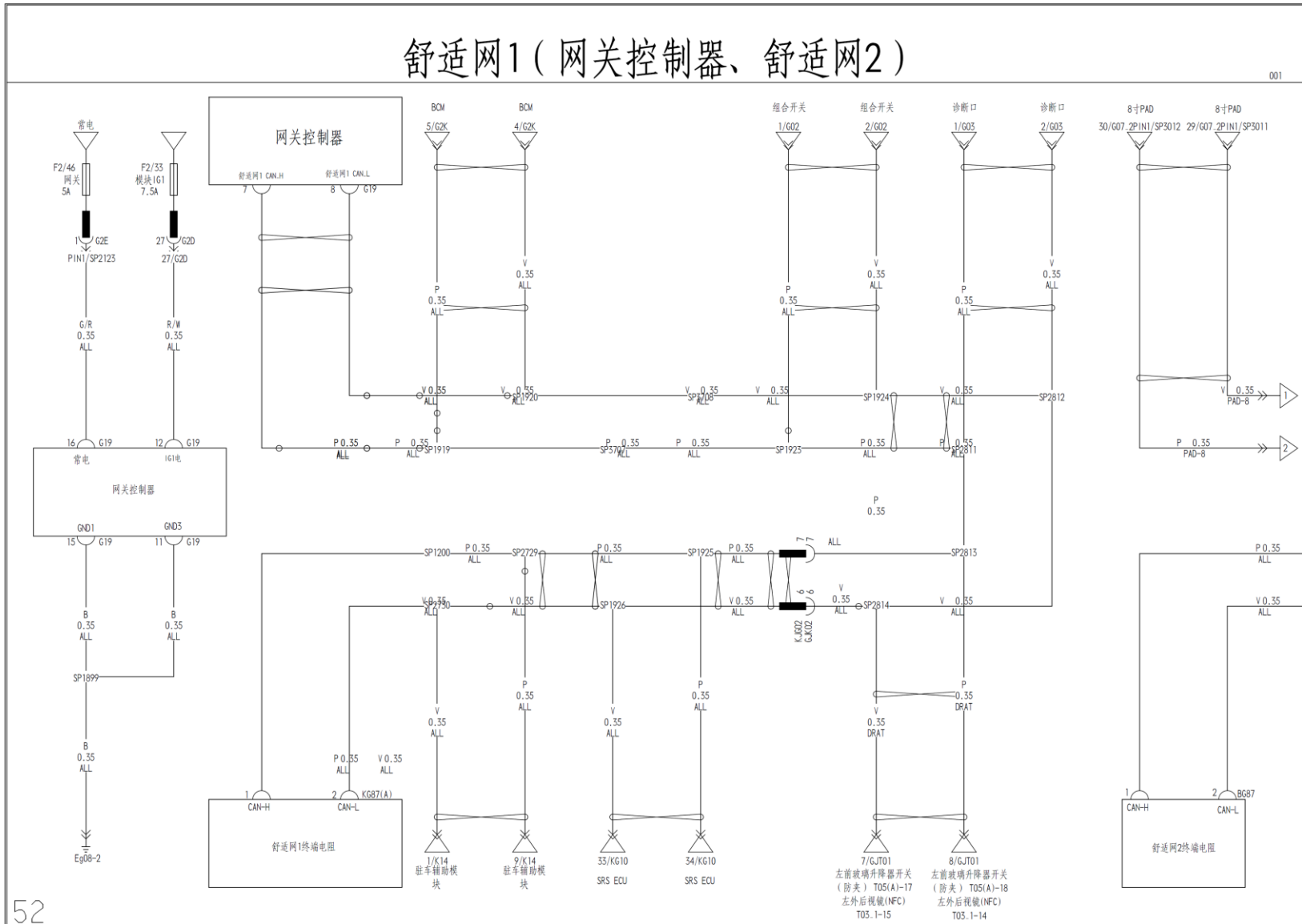

52

舒适网2 (网关控制器)

002

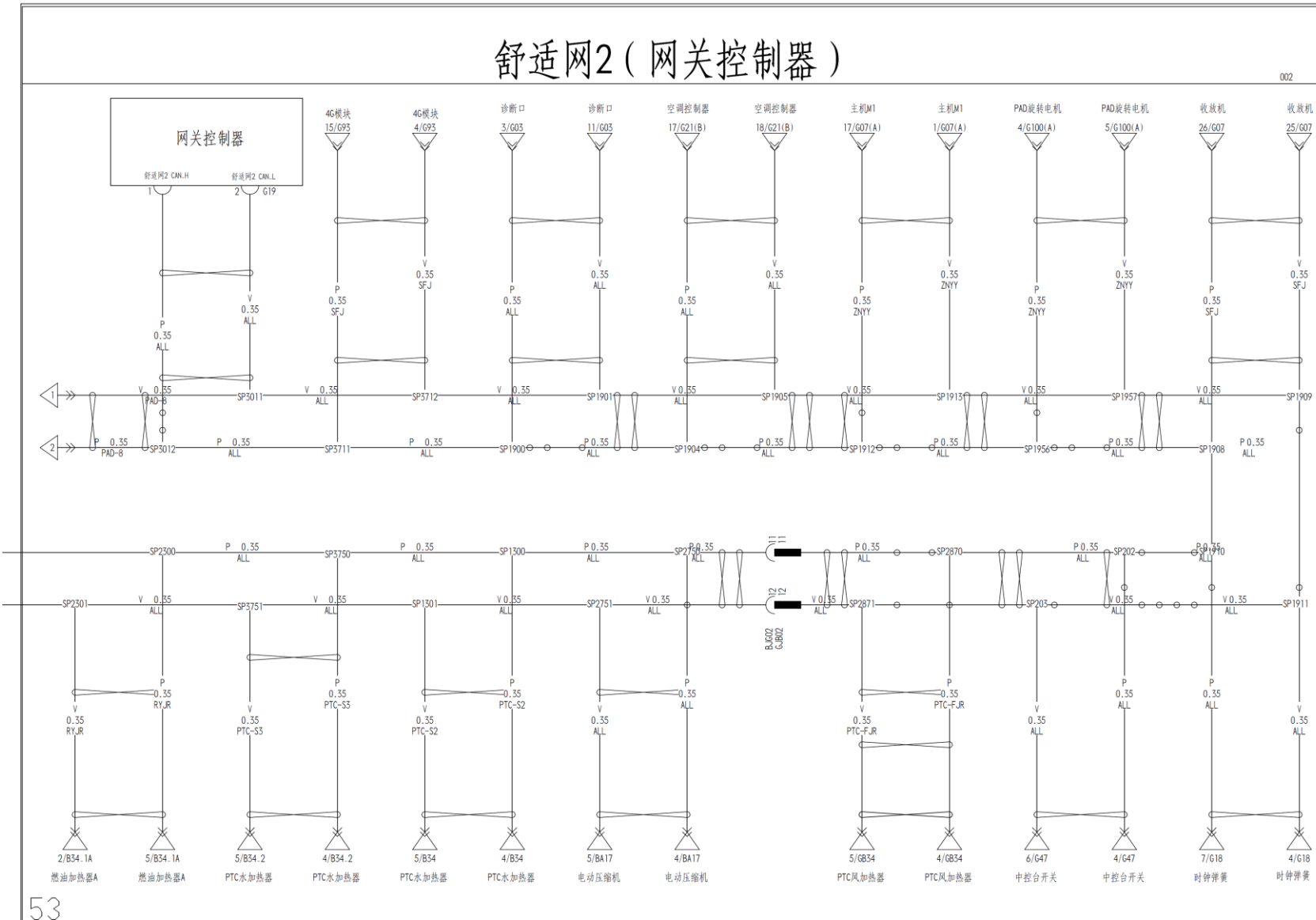



动力网 (网关控制器)

003

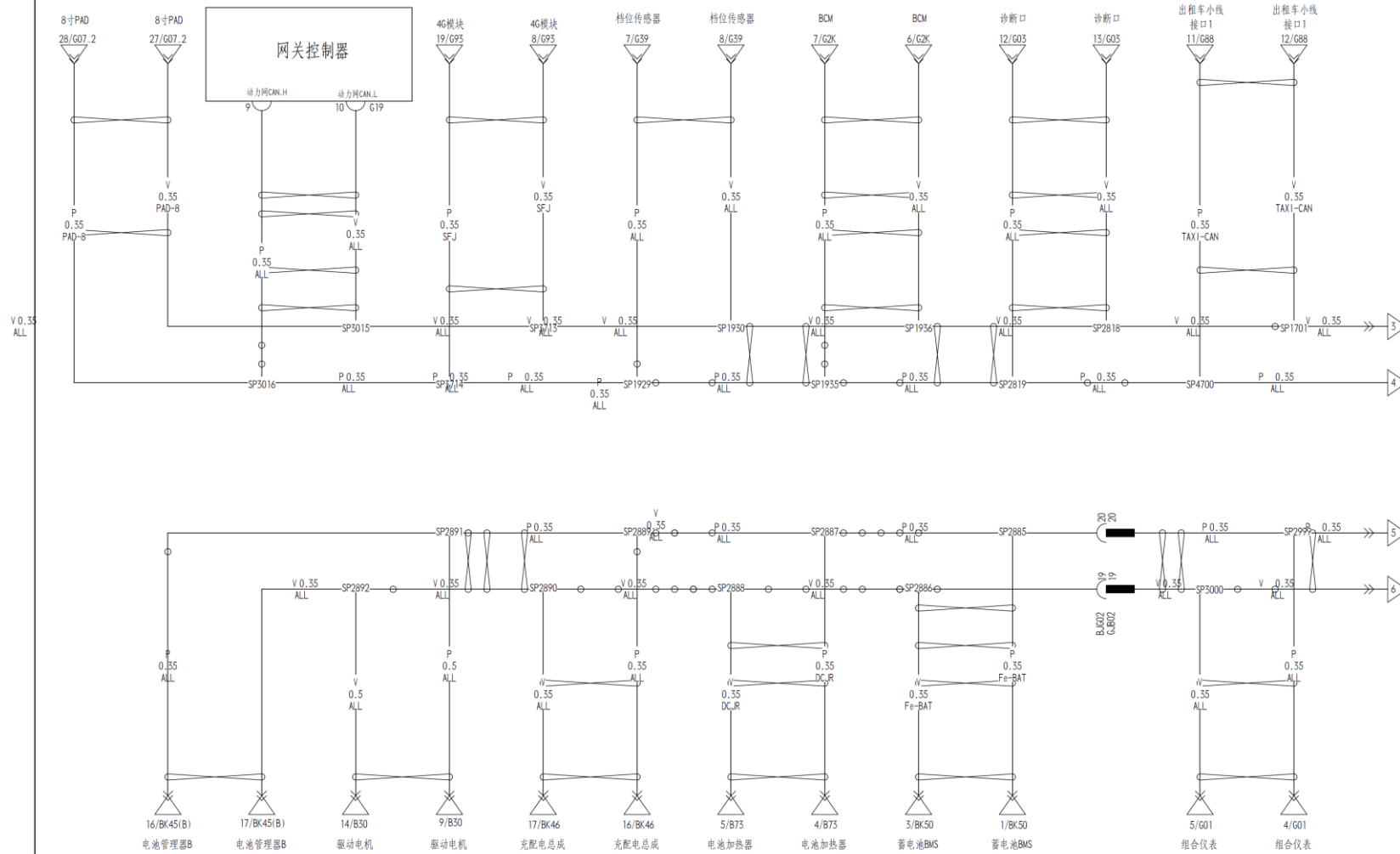

ESC网 (网关控制器、动力网)

004

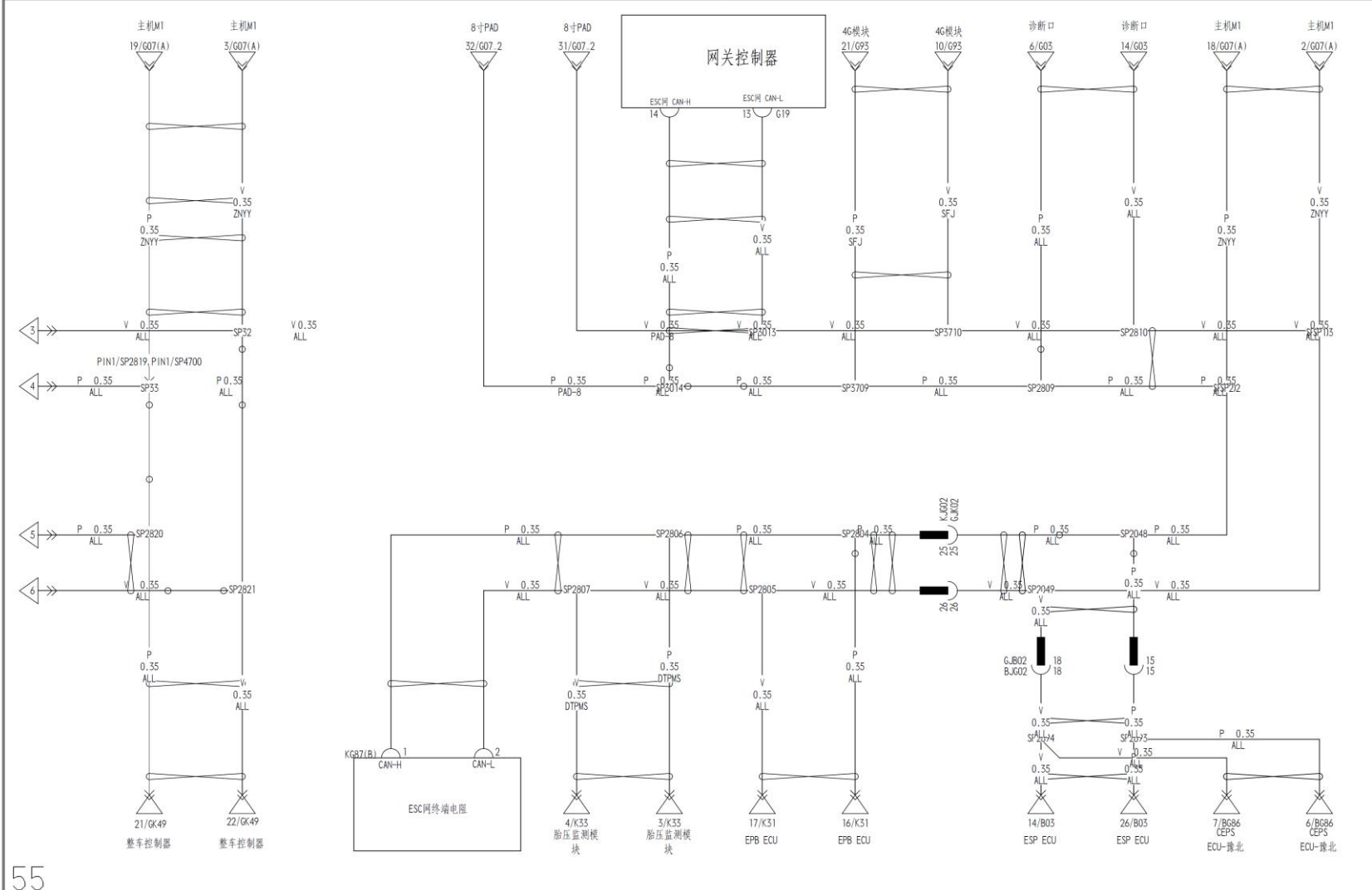



出租车小线

001

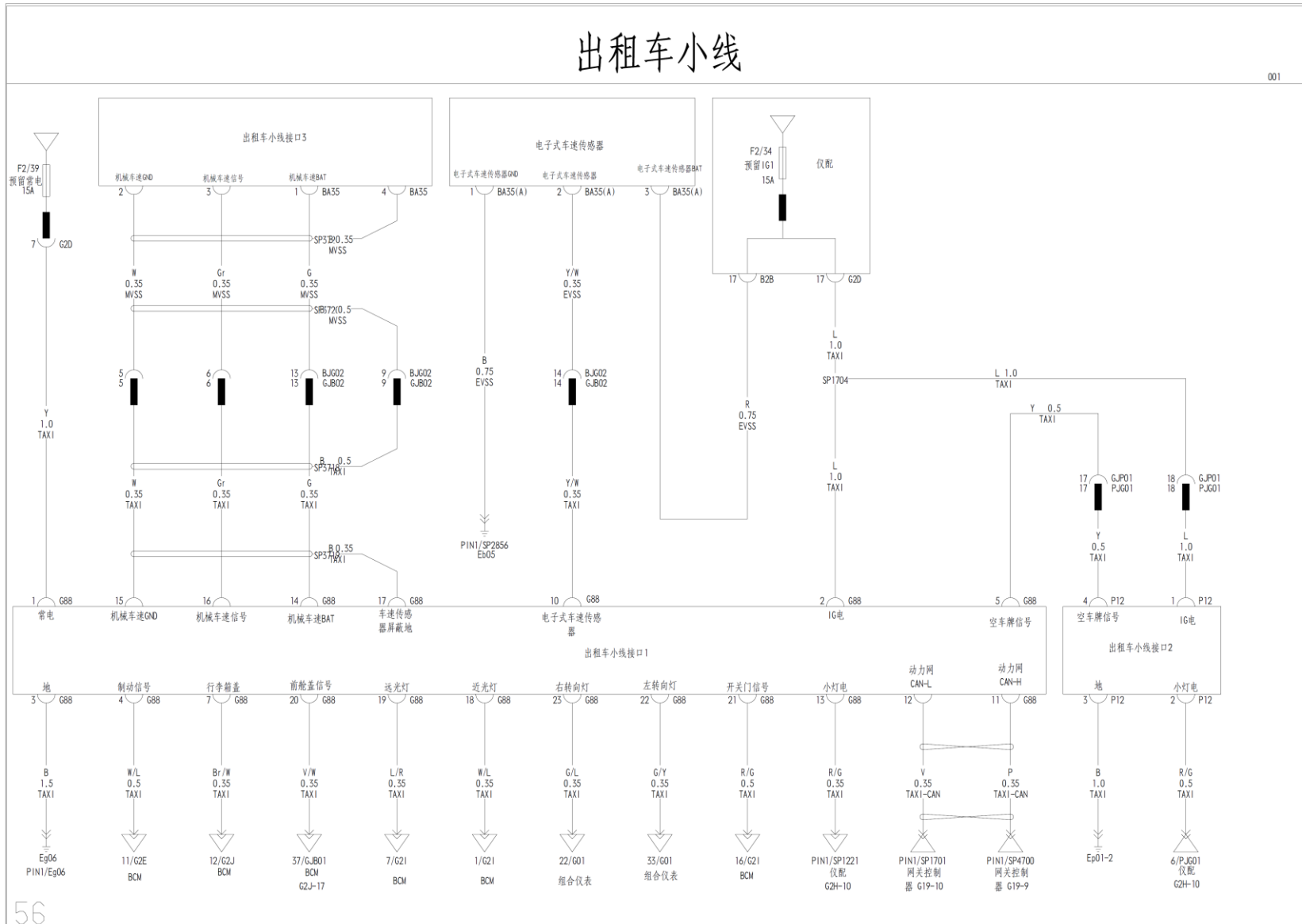

56

4G模块

002

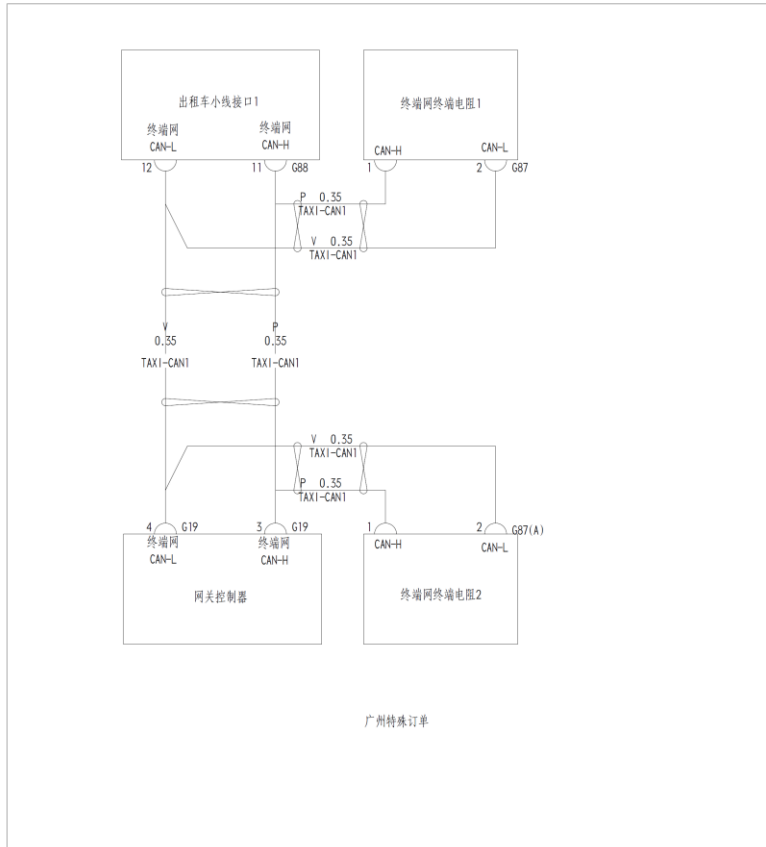

57



仪表板线束搭铁

001

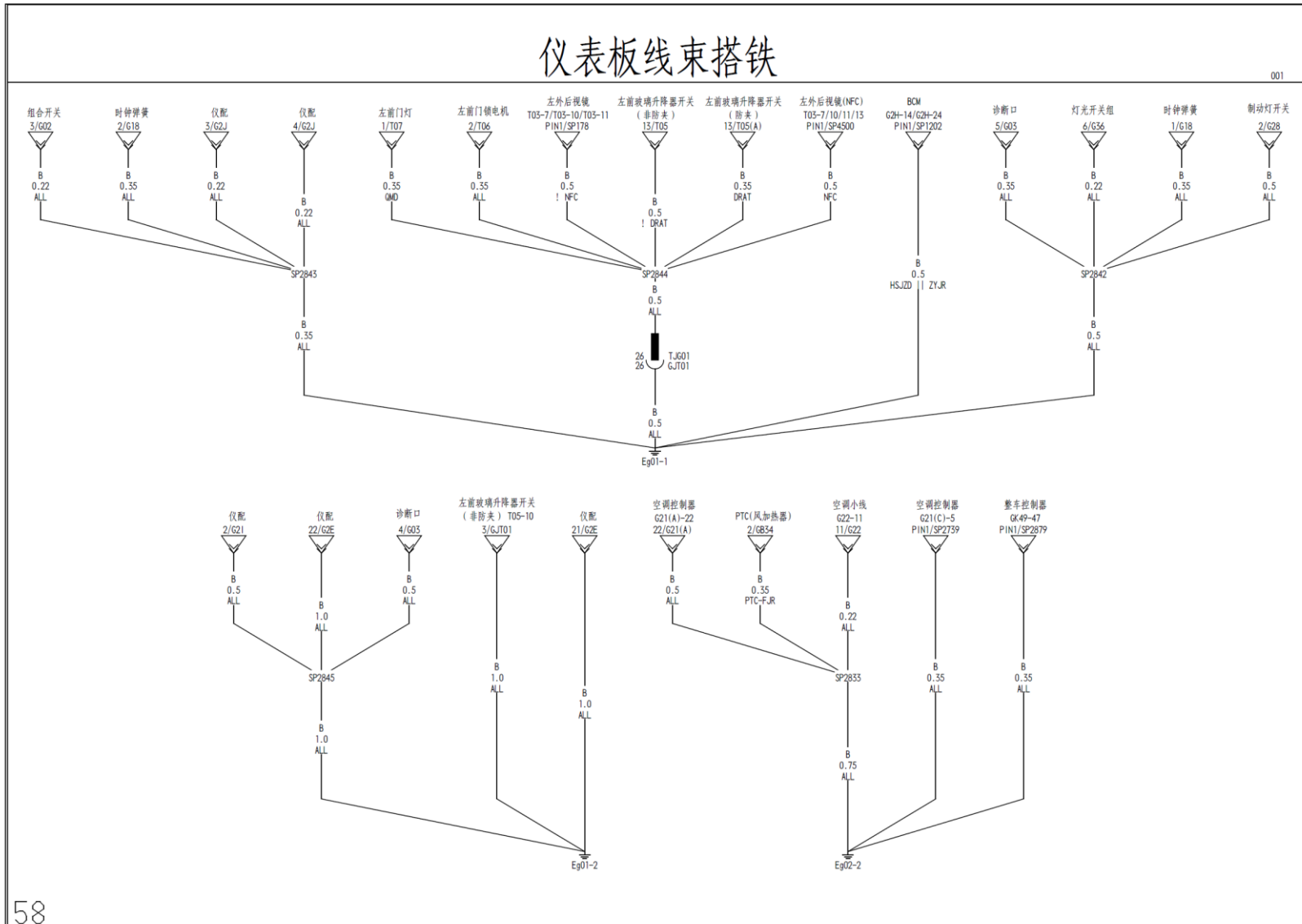



仪表板线束搭铁

002

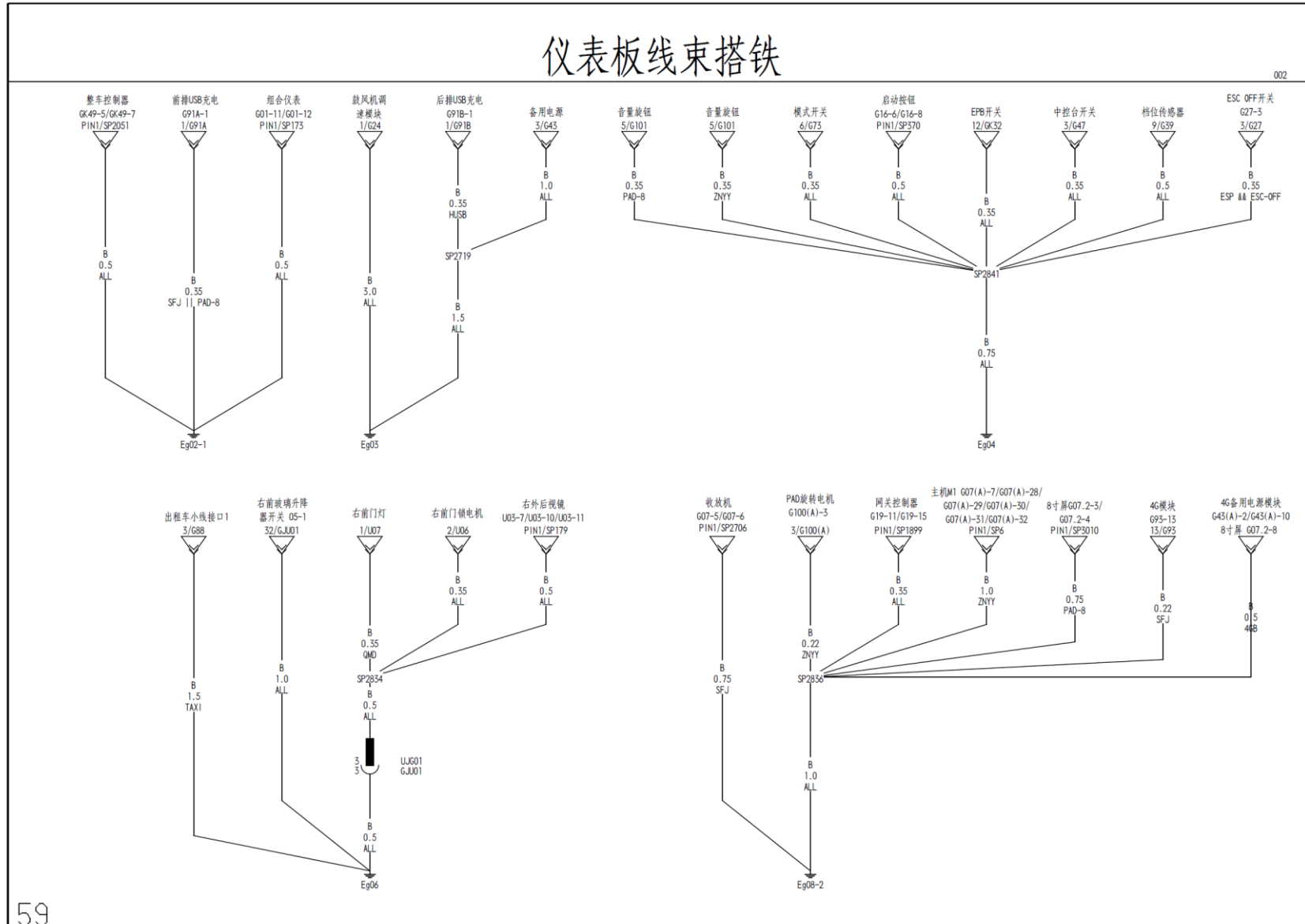



前舱线束搭铁

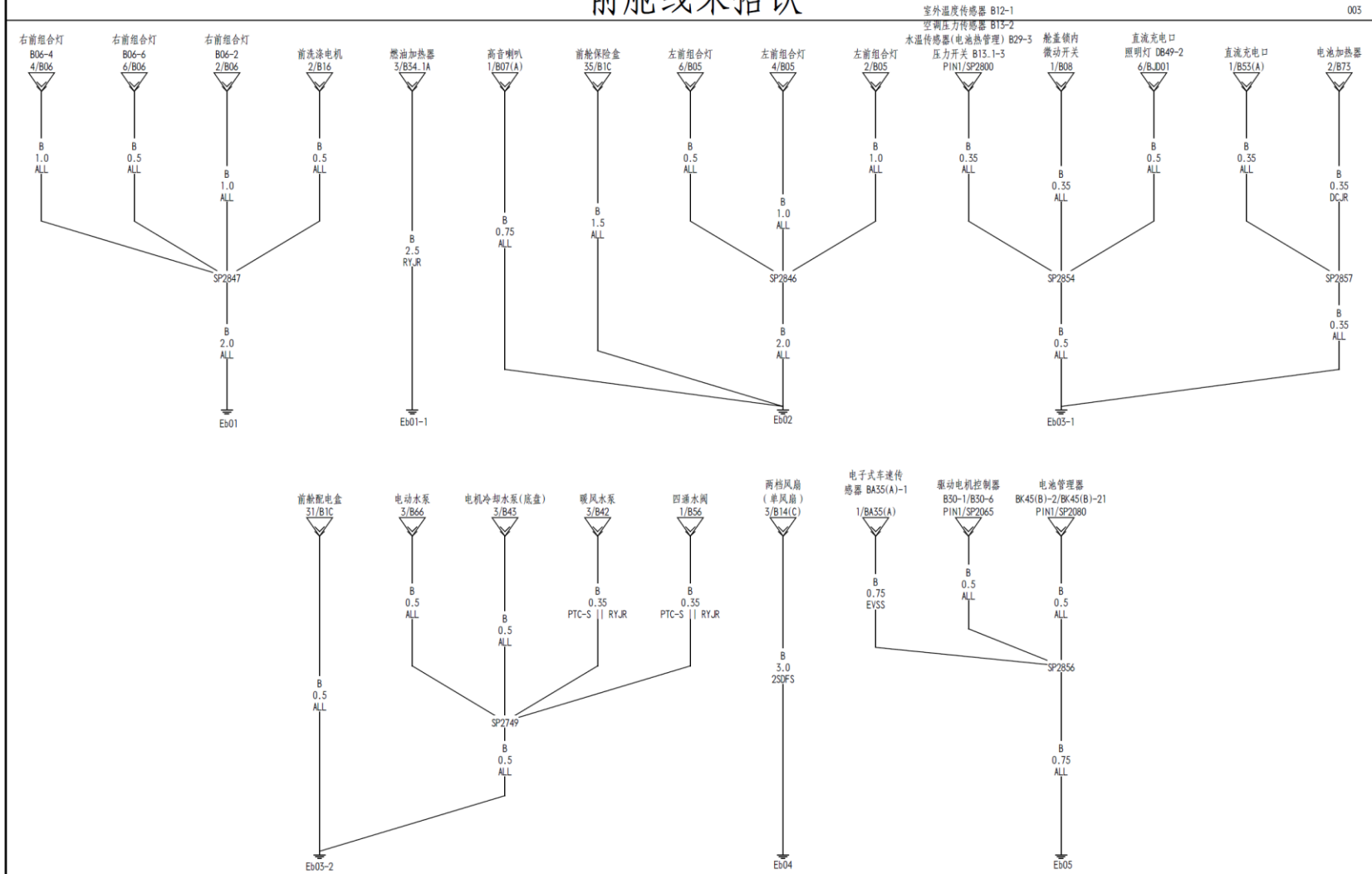



前舱线束搭铁

004

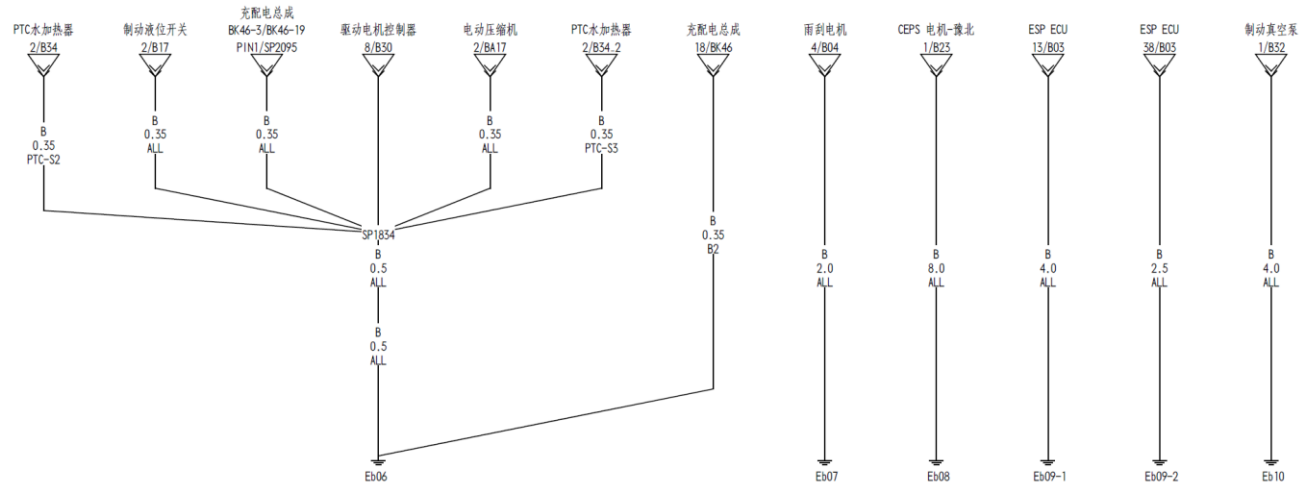



地板线束搭铁

005

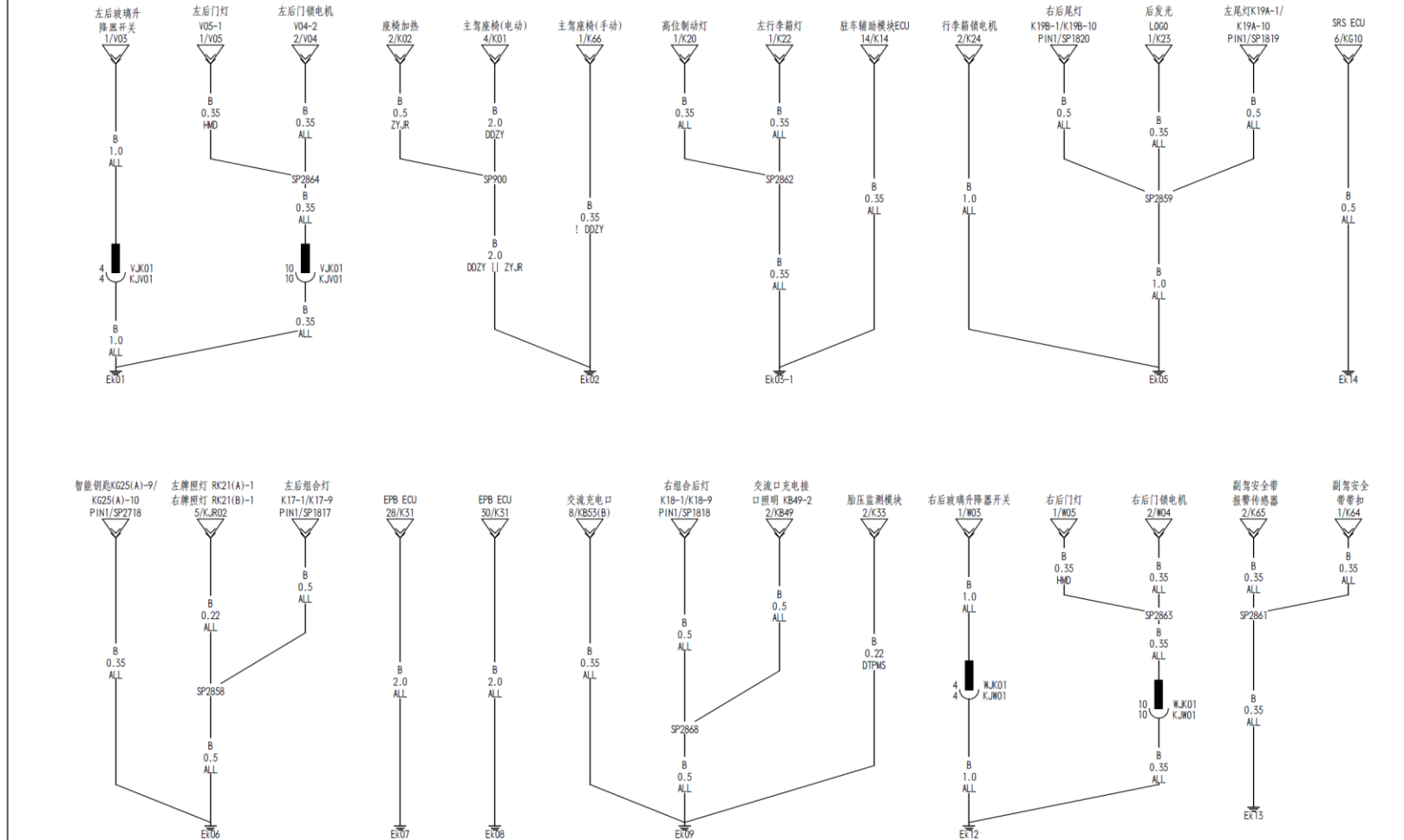

62

顶棚线束搭铁

006

